



Technical Documentation

Pressure reducing
valves / Pressure
retaining valves

Pressure relief valves

Special valves

Table of contents

	Page
1. Pressure reducing valve V782	4
2. Pressure reducing valve V82	9
3. Pressure reducing valve V182	14
4. Pressure retaining valve V786	18
5. Pressure retaining valve V186/V86	23
6. Pressure relief valve V185/V85	28
7. Diaphragm pressure gauge guard Z700/Z701	32
8. Water jet suction pump P20	35
9. Filler and breather valves V95/V91	45
10. Float valve V140	48
11. Throttle sleeve V251	50

Pressure Reducing Valve V782



General

Function

The V782 Pressure Reducing Valve reduces the pressure within the system to a pre-set value. By using the differential pressure, the pressure reducing valve adjusts itself to the set working pressure. The outlet pressure (working pressure) is not directly related to the inlet pressure. If the outlet pressure increases or decreases above/below the desired value, the diaphragm is lifted against the spring force or pressed down by the spring force, as the case may be, by the outlet pressure. The pressure reducing valve begins to close/open until a state of equilibrium is re-established; in other words, the outlet pressure remains constant irrespective of an increasing or decreasing inlet pressure.

The wide range of materials available for the housings (PVC-U, PP, PVDF) and the diaphragms (EPDM, EPDM-PTFE-coated) cover many areas of application for technically pure, neutral and aggressive fluids as well as ultra-pure water applications. For more information, please refer to the Georg Fischer Piping Systems List of Resistance. We recommend installing a strainer upstream to avoid any breakdowns.

Special features

- All parts in contact with the medium are made of highly resistant plastics.
- The actuator is separated and hermetically sealed off from the flow section by the control diaphragm.
- The working pressure is set with an adjusting screw and locked with a locknut.
- The streamlined design of the housing makes for good flow rates.
- The large control surface and the spiral spring keep standard tolerances small.
- No auxiliary energy is required to operate the valve.
- The valve is largely maintenance-free and can be installed in any position.
- Valve can also be adjusted under working pressure.

Technical data V782

Available materials

Valve housing: PVC-U, PP, PVDF
 Diaphragm: EPDM, EPDM-PTFE-coated
 Pressure range: DN 10-40 0.5-10 bar

Allowable working temperature

PVC-U 0 to + 60 °C
 PP -10 to + 80 °C
 PVDF -20 to + 100 °C

Working pressure

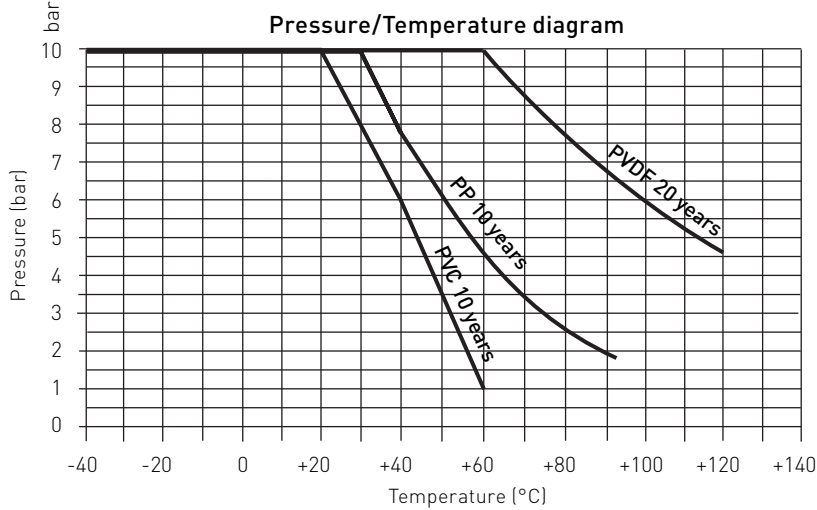

- **Hysteresis**
approx. 0.1 to 0.4 bar
- **Pressure difference between inlet and outlet**
min. 1 bar

Attention: If the secondary pressure is increased additionally by back pressure, the pressure regulating valve will act as a check valve. This back pressure can under certain circumstances lead to the destruction of the valve piston.

Adjustment range on outlet with an inlet pressure of 10 bar
0.5 to 9.0 bar

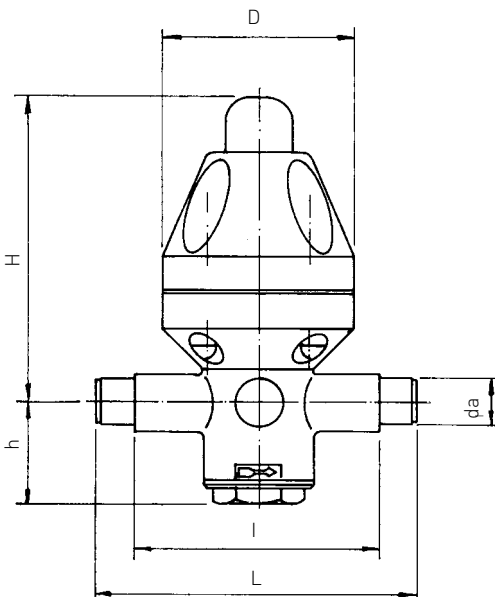

Dimensions and weight V782

da	DN	L: PVC-U cement spigots PP/PVDF fusion spigots	L: PVDF-HP/PP Butt fusion spigots BC F/IR	l	H	h	D
16	10	134	-	102	138	48	83
20	15	134	172	102	138	48	83
25	20	154	190	110	205	65	112
32	25	154	190	110	205	65	112
40	32	224	262	162	248	95	165
50	40	224	262	162	248	95	165

da	DN	Weight (kg) PVC-U	PP	PVDF
16	10	0.62	0.45	0.67
20	15	0.62	0.46	0.68
25	20	1.70	1.24	1.84
32	25	1.70	1.25	1.84
40	32	4.84	3.91	6.31
50	40	4.84	3.93	6.24

Cement and fusion spigots according to DIN/ISO

- p_A = formulated operating pressure
- p_0 = opening pressure
- p_S = closing pressure
- $p_S - p_0$ = hysteresis
- $p_S - p_A$ = flow-related pressure drop in valve
- $p_S - p_{min}$ = max. pressure reduction in relation to flow rate

Operational characteristics for a pressure reducing valve (representation not full scale)

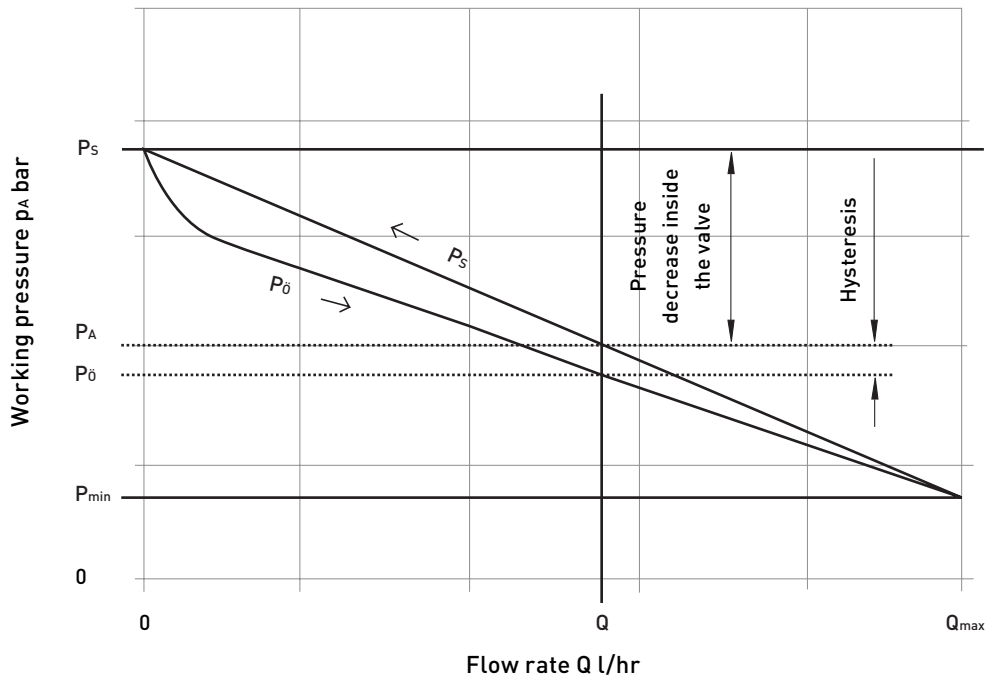

Example 1: -----

For a flow rate of approx. 3500 l/hr, an outlet pressure (working pressure) of 4 bar is required. Inlet pressure min. 5 bar or greater.

Look for the given flow rate on the x axis of the respective nominal diameter curve. When the appropriate curve has been found, check if the valve is in the desired pressure range (here 4 bar). In this example, the hysteresis would be 0.5 bar and the pressure drop 1 bar.

Example 2:

The valve is adjusted at a desired pressure of 3 bar at 0 conveyance. If we take a flow rate of 2500 l/hr, the pressure drop in the valve would be approx. 0.8 bar.

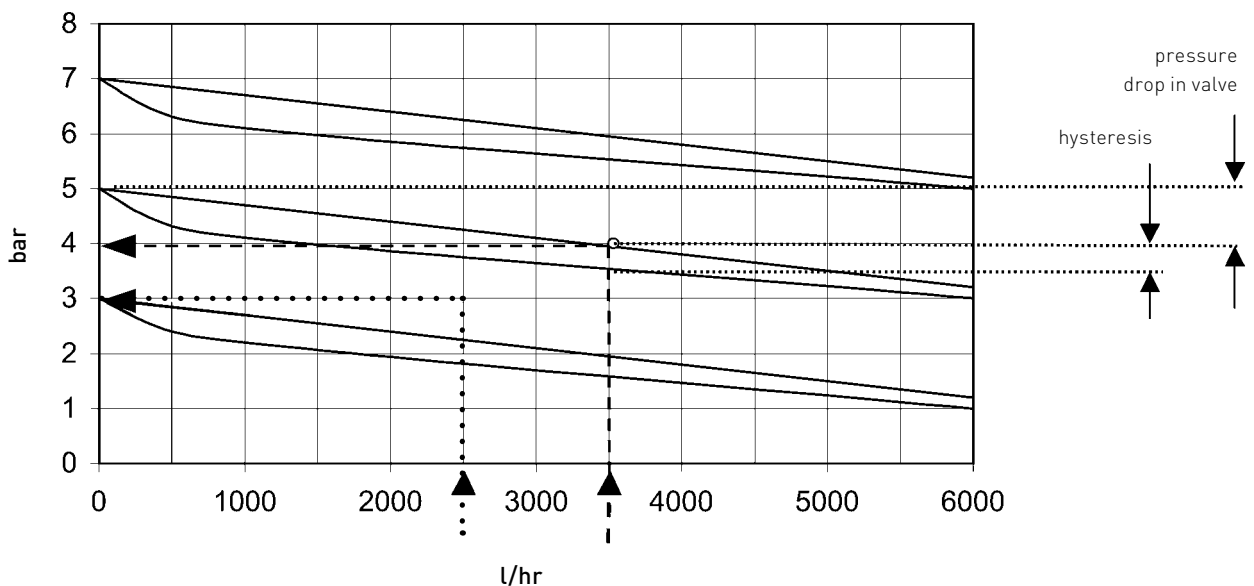

Characteristics V782

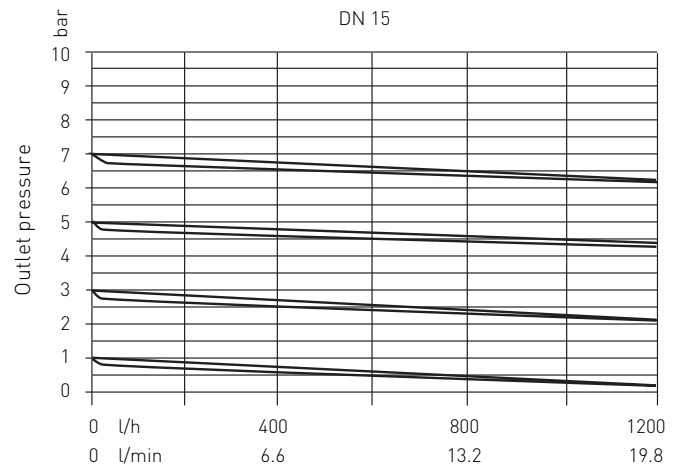
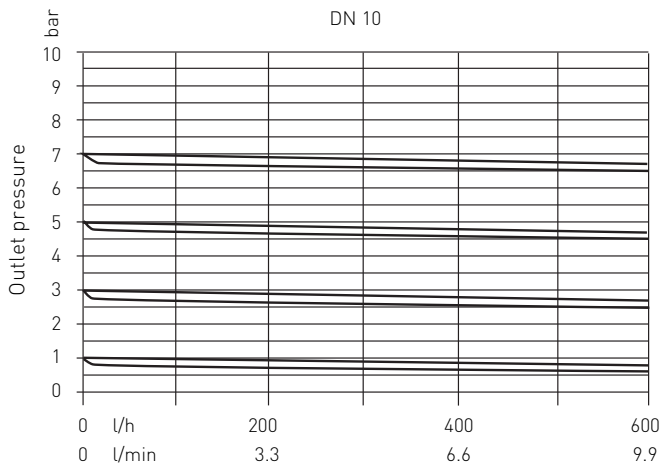

Characteristics are valid for a flow rate of 2 m/s

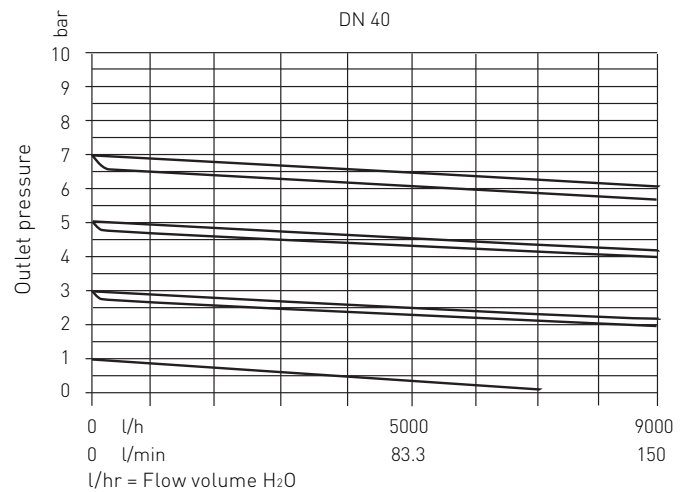
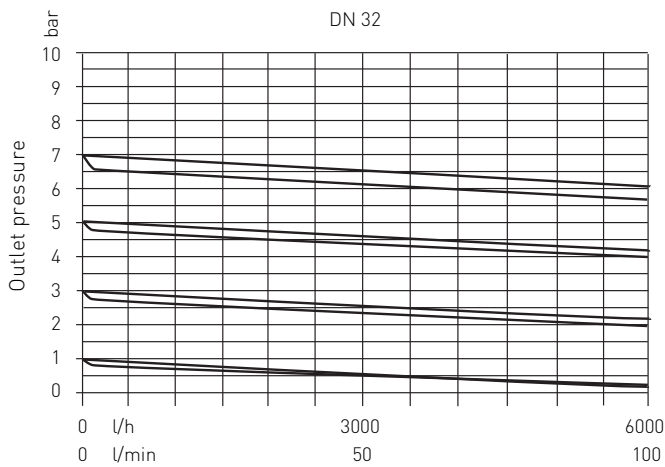
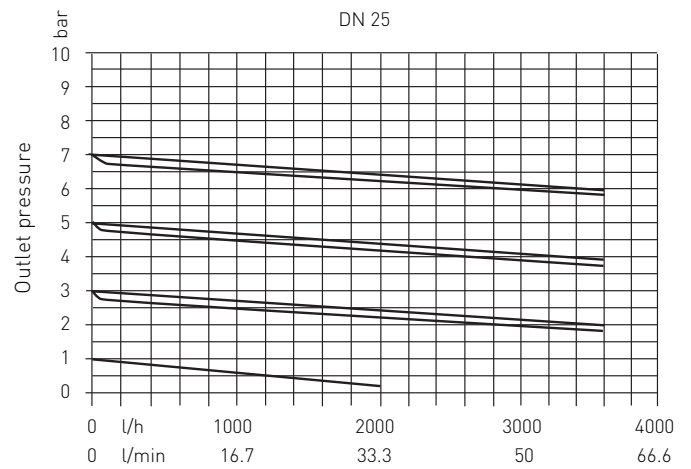
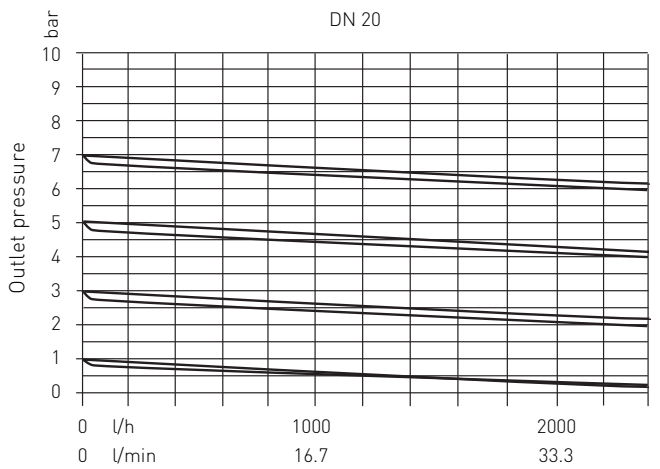

Order number

DN	d	Adj. range in bar	PVC-U		PP Standard		PP/IR spigots		PVDF-PTFE Standard	HP-Version* BCF/IR spigots
			EPDM	PTFE	EPDM	PTFE	EPDM	PTFE		
10	16	0.5 – 9.0	199 041 060	199 041 066	199 041 072	199 041 078	-	-	199 041 084	-
15	20	0.5 – 9.0	199 041 061	199 041 067	199 041 073	199 041 079	199 041 299	199 041 404	199 041 085	199 041 192
20	25	0.5 – 9.0	199 041 062	199 041 068	199 041 074	199 041 080	199 041 300	199 041 405	199 041 086	199 041 193
25	32	0.5 – 9.0	199 041 063	199 041 069	199 041 075	199 041 081	199 041 301	199 041 406	199 041 087	199 041 194
32	40	0.5 – 9.0	199 041 064	199 041 070	199 041 076	199 041 082	199 041 302	199 041 407	199 041 088	199 041 195
40	50	0.5 – 9.0	199 041 065	199 041 071	199 041 077	199 041 083	199 041 303	199 041 408	199 041 089	199 041 196

* PVDF – PTFE Standard with IR spigots on request
Flange and union versions on request

Sectional drawing V782

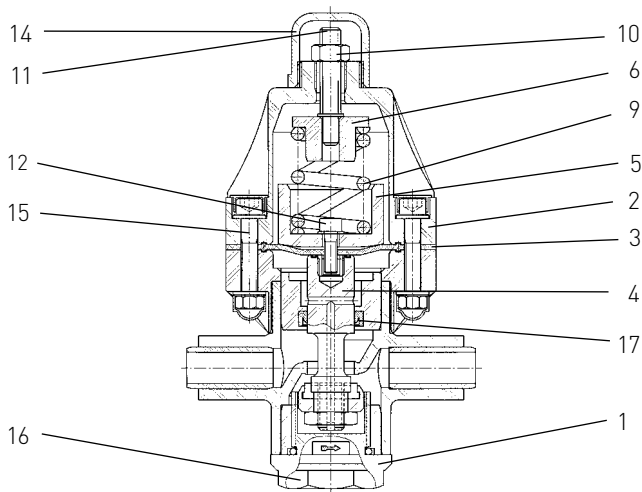

Parts

No.	Description
1.	Valve body
2.	Uppervalue body
3.*	Diaphragm
4.*	Piston
5.	V782: Compressor
6.	V782: Spring plate
9.*	Compression spring
10.	Lock nut
11.	Adjusting screw
12.	Hexagonal socket-head bolt
14.	Cap
15.	Hexagonal socket-head bolt with nut and covering cup
16.	Valve bottom with O-ring
17.*	Ring seal

* Parts subject to wear or recommended spare parts

Dismantling instructions

1. Dismantle the upper valve body:
 - 1.1 Put the valve in an upright position
 - 1.2 Unscrew the cap (14)
 - 1.3 Undo the locknut on the adjusting screw (11) and undo the adjusting screw until the compression spring (9) is fully released
 - 1.4 Remove the covering caps on the screws (15) of the upper body and undo the screws
 - 1.5 Lift the upper body (2) upwards and remove the spring plate (6) and the spring (9)
2. Dismantle the lower valve body and the diaphragm:
 - 2.1 Carry out steps 1.1 to 1.5
 - 2.2 Unscrew the vent plug (16)
 - 2.3 Lay the valve on its side
 - 2.4 With a screwdriver on the underside of the piston (vent plug opening), prevent the piston from turning and at the same time use a hexagon socket screw key to unscrew the screw (12) in the pressure plate (5)
 - 2.5 Remove the screw (12), pressure plate (5) and diaphragm (3)
 - 2.6 Remove the piston (4) downwards
 - 2.7 Remove the ring seal (17) in the housing (1)

These steps are carried out in reverse order to reassemble!

Operating faults and possible causes

Fault	Cause	Correction
Valve not sealed at the diaphragm	Diaphragm not pressed on hard enough	Tighten screws (15)
Pressure rises above the set value	Piston (4) not sealed	Check piston and piston position and possibly replace
	Diaphragm (3) not sealed	Replace diaphragm, dismantle upper valve body 1.1-2.5
	Ring seal (17) not sealed	Replace seal, dismantle lower valve body 1.1-2.7
Valve closed – will not open	Control holes in piston are blocked	Dismantle piston 1.1-2.6 and clean holes
	Installed wrong way round	Turn valve round, check arrow indicating flow direction
Lower valve body not sealed at vent plug	O-ring not sealed	Dismantle vent plug, 2.2 and replace O-ring
Medium leaks out at the adjusting screw	Diaphragm is faulty	Replace diaphragm, dismantle lower valve body 1.1-2.5

Installation advice:

We recommend installing the fittings between 2 detachable pipe connections.

Pressure Reducing Valve V82



General

Function

The V82 Pressure Reducing Valve reduces the pressure within the system to a pre-set value. By using the differential pressure, the pressure reducing valve adjusts itself to the set working pressure. The outlet pressure (working pressure) is not directly related to the inlet pressure. If the outlet pressure increases or decreases above/below the desired value, the diaphragm is lifted against the spring force or pressed down by the spring force, as the case may be, by the outlet pressure. The pressure reducing valve begins to close/open until a state of equilibrium is re-established, in other words, the outlet pressure remains constant irrespective of an increasing or decreasing inlet pressure.

The wide range of materials available for the housings (PVC-U, PP, PVDF) and the diaphragms (EPDM, EPDM-PTFE-coated) cover many areas of application for technically pure, neutral and aggressive fluids as well as ultra-pure water applications. For more information, please refer to the Georg Fischer Piping Systems List of Resistance. We recommend installing a strainer upstream to avoid any breakdowns.

Special features

- All parts in contact with the medium are made of highly resistant plastics.
- The actuator is separated and hermetically sealed off from the flow section by the control diaphragm.
- The working pressure is set with an adjusting screw and locked with a locknut.
- The large control surface and the disc spring keep standard tolerances small.
- No auxiliary energy is required to operate the valve.
- The valve is largely maintenance-free and can be installed in any position.
- Valve can also be adjusted under working pressure.
- Standard version with manometer.

Technical data V82

Available materials

Valve housing:	PVC-U, PP, PVDF
Diaphragm:	EPDM, EPDM-PTFE-coated
Pressure ranges:	DN 10-50 0.5-10 bar DN 65-80 0.5-6 bar DN 100 0.5-4 bar

Allowable working temperatures

PVC-U	0 to + 60 °C
PP	-10 to + 80 °C
PVDF	-20 to + 100 °C

- **Hysteresis**

approx. 0.4 to 1.0 bar

Adjustment range on outlet with an inlet pressure of 10 bar

0.5 to 9.0 bar

- **Pressure difference between inlet and outlet**

1 bar

Dimensions and weight V82

da	DN	Ø D	h	H	L: PVC-U cement spigots PP/PVDF fusion spigots	L: PVDF-HP/PP butt fusion spigots BCF/IR
16	10	70	100	130	134	-
20	15	70	100	130	134	150
25	20	100	134	180	174	190
32	25	100	134	180	174	190
40	32	130	175	230	224	240
50	40	130	175	230	224	240
63	50	150	210	285	244	260
75	65	200	250	350	300	300
90	80	250	305	425	360	360
110	100	300	345	495	420	420

da	DN	PVC-U, PP/PVDF		Weight (kg) - PVC-U			PP	PVDF
		L1	L2	L	L1	L2	L	L
16	10	154	140	0.68	0.73	0.84	0.55	0.79
20	15	154	140	0.68	0.76	0.88	0.51	0.78
25	20	185	180	1.35	1.49	1.64	1.03	1.62
32	25	185	180	1.63	1.56	1.75	1.02	1.59
40	32	248	230	2.96	3.32	3.62	2.24	5.32
50	40	252	230	2.96	3.38	3.74	2.24	5.32
63	50	280	250	5.18	5.90	6.175	3.96	9.33
75	65	-	306	10.43	-	11.77	7.91	13.76
90	80	-	370	19.63	-	21.25	12.91	-
110	100	-	430	31.64	-	33.76	23.30	-

Cement and fusion spigots according to DIN/ISO

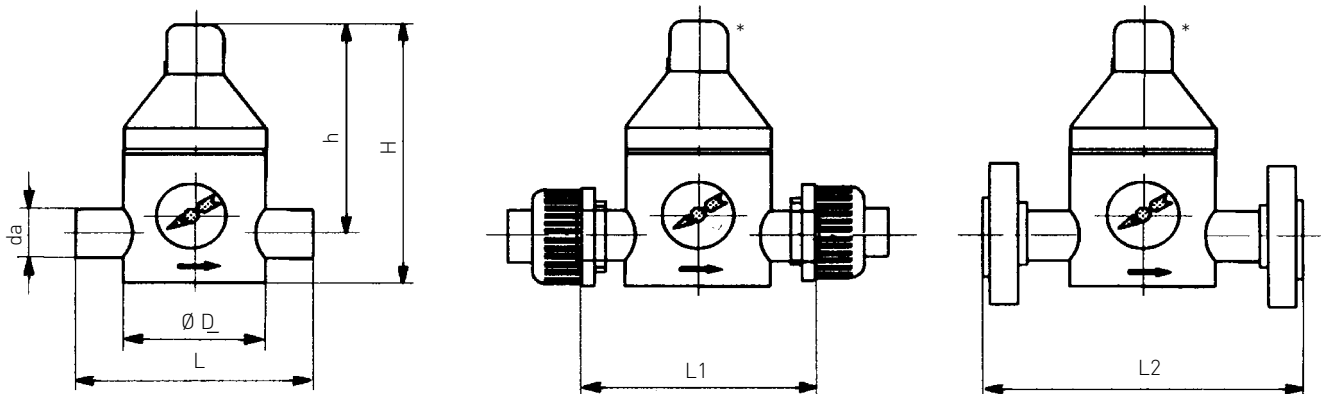

* special versions on request

Characteristics V82

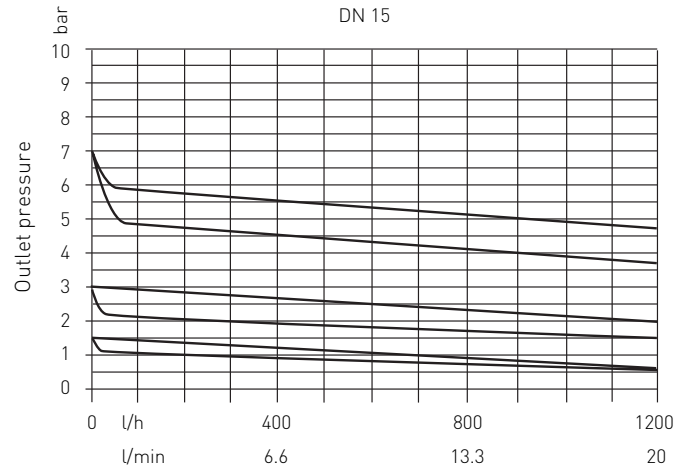
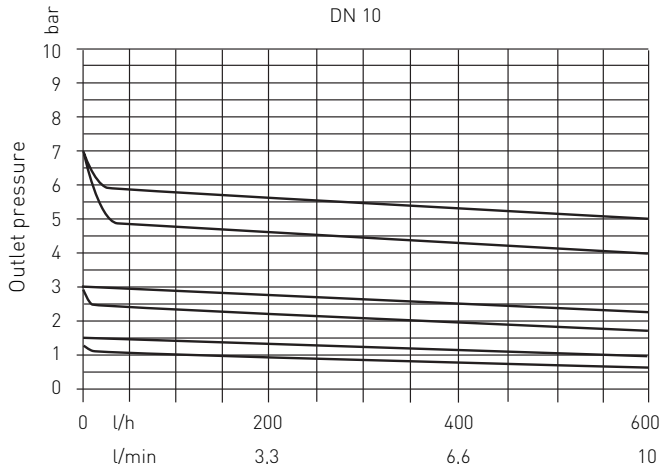

Characteristics are valid for a flow rate of 2 m/s

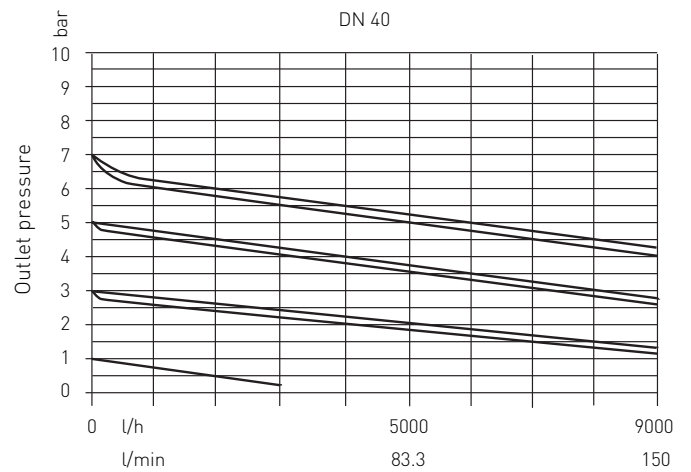
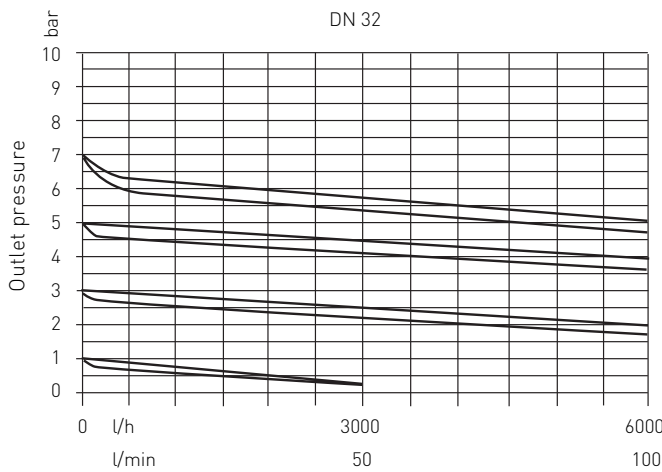
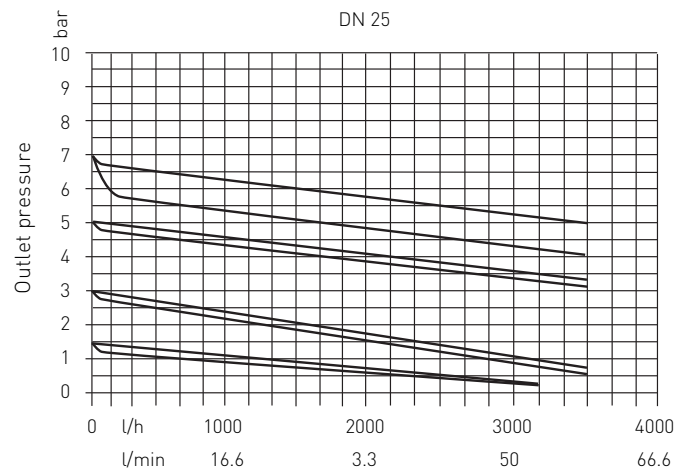
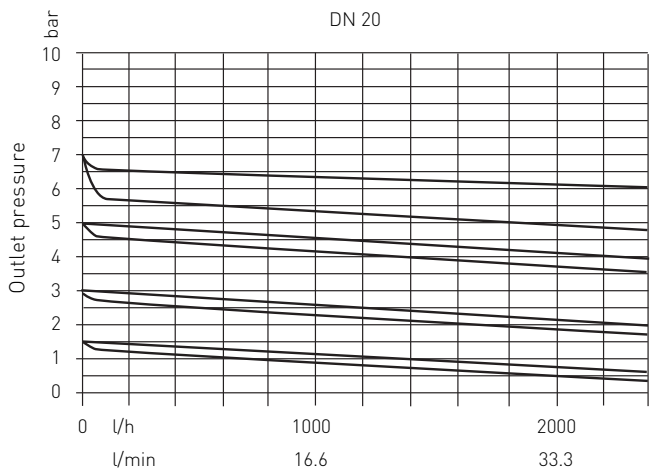

l/hr, l/min = Flow volume H₂O

Characteristics V82

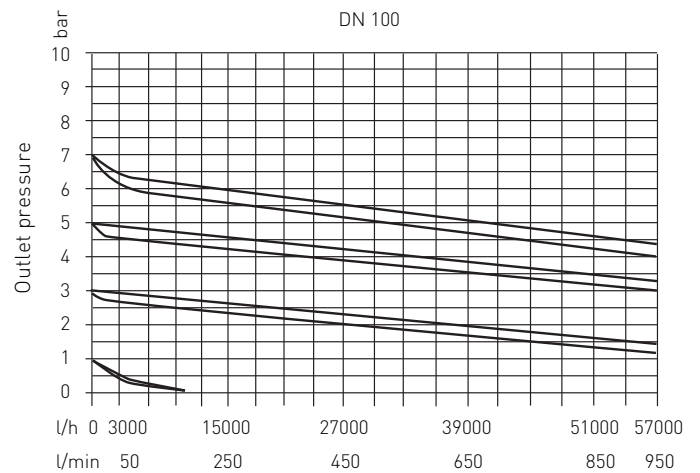
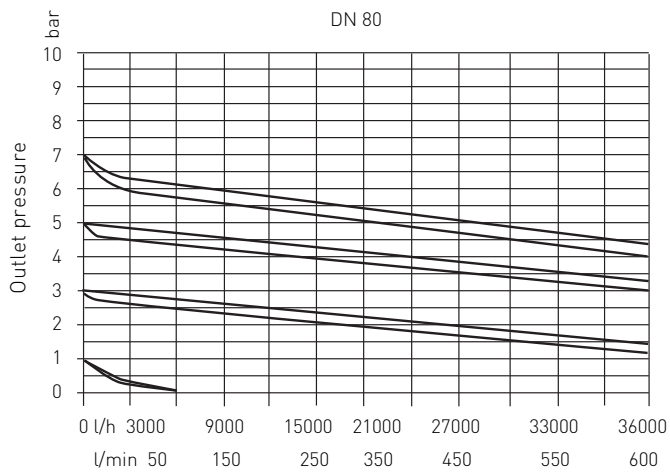
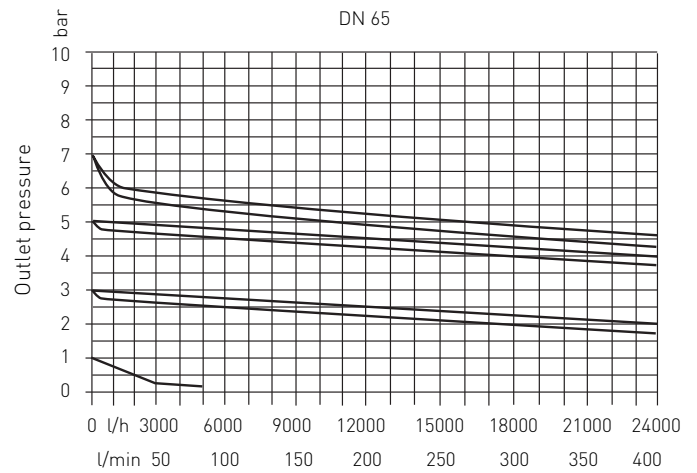
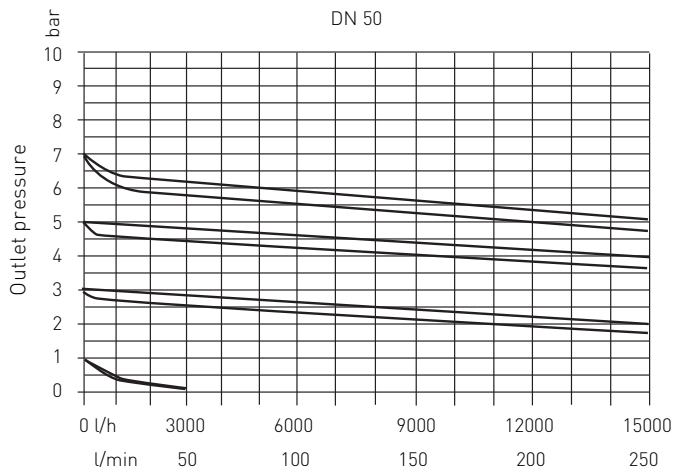

Order number

DN	d	Adj. range in bar	PVC-U		PP		PP/IR spigots		PVDF-PTFE Standard	HP Version* BCF/IR spigots
			EPDM	PTFE	EPDM	PTFE	EPDM	PTFE		
10	16	0.5 - 9.0	199 041 012	199 041 022	199 041 032	199 041 042	-	-	199 041 052	-
15	20	0.5 - 9.0	199 041 013	199 041 023	199 041 033	199 041 043	199 041 411	199 041 421	199 041 053	199 041 184
20	25	0.5 - 9.0	199 041 014	199 041 024	199 041 034	199 041 044	199 041 412	199 041 422	199 041 054	199 041 185
25	32	0.5 - 9.0	199 041 015	199 041 025	199 041 035	199 041 045	199 041 413	199 041 423	199 041 055	199 041 186
32	40	0.5 - 9.0	199 041 016	199 041 026	199 041 036	199 041 046	199 041 414	199 041 424	199 041 056	199 041 187
40	50	0.5 - 9.0	199 041 017	199 041 027	199 041 037	199 041 047	199 041 415	199 041 425	199 041 057	199 041 188
50	63	0.5 - 9.0	199 041 018	199 041 028	199 041 038	199 041 048	199 041 416	199 041 426	199 041 058	199 041 189
65	75	0.5 - 6.0	199 041 019	199 041 029	199 041 039	199 041 049	199 041 417	199 041 427	199 041 059	-
80	90	0.5 - 6.0	199 041 020	199 041 030	199 041 040	199 041 050	199 041 418	199 041 428	-	-
100	110	0.5 - 4.0	199 041 021	199 041 031	199 041 041	199 041 051	199 041 419	199 041 429	-	-

* BCF fusion only possible up to DN 50

PVDF - PTFE Standard with IR spigots on request

Flange and union versions on request

Sectional drawing V82

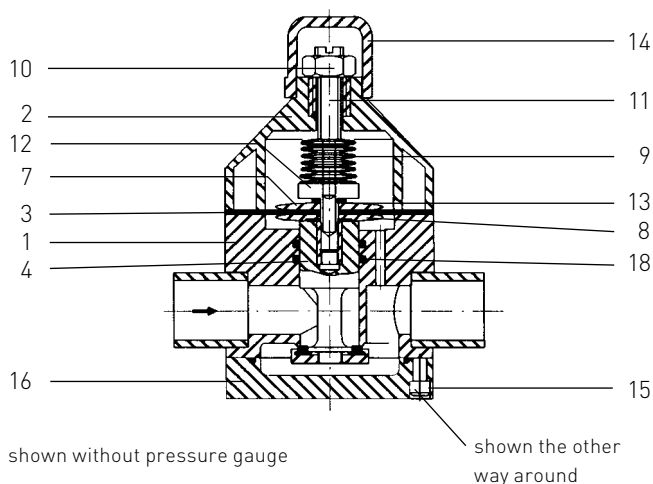

Parts

No.	Description
1.	Valve body
2.	Upper valve body
3.*	Diaphragm
4.*	Piston
7.	V82: Pressure plate (top)
8.	V82: Pressure plate (bottom)
9.*	Compression spring
10.	Lock nut
11.	Adjusting screw
12.	Hexagonal socket-head bolt
13.	Washer
14.	Cap
15.	Hexagonal socket-head bolt
16.	Valve bottom with O-ring
18.*	O-ring

* Parts subject to wear or recommended spare parts

Installation and operating advice

- Note the direction of flow! Indicated by the arrow on the valve.
- We recommend fitting the valve between 2 detachable pipe connections (flanges or screw fastenings).
- Can be installed in any position with no effect on functioning.
- Where the medium is dirty or particle-laden, we recommend installing a strainer to avoid any breakdowns.

Dismantling instructions

- Dismantle the upper valve body:
 - Put the valve in an upright position
 - Unscrew the cap (14)
 - Undo the locknut on the adjusting screw (11) and undo the adjusting screw until the compression spring (9) is fully released
 - Undo the screws (15)
 - Lift the upper body (2) upwards and remove the spring plate (6) and the spring (9)
- Dismantle the lower valve body and the diaphragm:
 - Carry out steps 1.1 to 1.5
 - Unscrew the vent plug (16)
 - Lay the valve on its side
 - With a screwdriver on the underside of the piston (vent plug opening), prevent the piston from turning and at the same time use a hexagon socket screw key to unscrew the screw (12) in the pressure plate (5)
 - Remove the screw (12), pressure plate (5) and diaphragm (3)
 - Remove the piston (4) downwards

These steps are carried out in reverse order to reassemble!

Operating faults and possible causes

Fault	Cause	Correction
Valve not sealed at the diaphragm	Diaphragm not pressed on hard enough	Tighten screws (15)
Pressure rises above the set value	Piston (4) not sealed	Check piston and piston position and possibly replace
	Diaphragm (3) not sealed	Replace diaphragm, dismantle upper valve body 1.1-2.5
Valve closed – will not open	Control bores in housing soiled	Dismantle piston 1.1-2.6 and clean holes
	Installed wrong way round	Turn valve round, check arrow indicating flow direction
Lower valve body not sealed at vent plug	O-ring not sealed	Dismantle vent plug, 2.2 and replace O-ring
Medium leaks out at the adjusting screw	Diaphragm is faulty	Replace diaphragm, dismantle lower valve body 1.1-2.5

Installation advice:

We recommend installing the fittings between 2 detachable pipe connections.

Pressure Reducing Valve V182



General

Function

The V182 Pressure Reducing Valve reduces the pressure within the system to a pre-set value. By using the differential pressure, the pressure reducing valve adjusts itself to the set working pressure. The outlet pressure (working pressure) is not directly related to the inlet pressure. If the outlet pressure increases or decreases above/below the desired value, the piston is lifted against the spring force or pressed down by the spring force, as the case may be, by the outlet pressure. The pressure reducing valve begins to close/open until a state of equilibrium is re-established, in other words, the outlet pressure remains constant irrespective of an increasing or decreasing inlet pressure.

The wide range of materials available for the housings (PVC-U, PP, PVDF) and the diaphragms (EPDM, EPDM-PTFE-coated) cover many areas of application for technically pure, neutral and aggressive fluids. For more information, please refer to the Georg Fischer Piping Systems List of Resistance. We recommend installing a strainer upstream to avoid any breakdowns.

Special features

- All parts in contact with the medium are made of highly resistant plastics.
- The control unit is hermetically sealed off from the flow element by the piston and the seal.
- The working pressure is set with an adjusting screw and locked with a locknut.
- Improved flow values are achieved by the flow-optimized design of the piston.
- The large control surface and the spiral spring keep standard tolerances small.
- No auxiliary energy is required to operate the valve.
- The valve is largely maintenance-free and can be installed in any position.
- Valve can also be adjusted under working pressure.
- Standard version with diaphragm-protected manometer.

Technical data V182

Available materials

Valve housing: PVC-U, PP, PVDF
 Piston-seal: EPDM, FPM
 Pressure ranges: DN 10-40 0.5-10 bar

Allowable working temperatures

PVC-U 0 to + 60 °C
 PP -10 to + 80 °C
 PVDF -20 to + 100 °C

- **Hysteresis**
approx. 0.3 to 0.5 bar

Adjustment range on outlet with an inlet pressure of 10 bar
0.5 to 9.0 bar

- **Pressure difference between inlet and outlet**
min. 1 bar

Dimensions and weight V182

da	DN	Ø D	h	H	L: PVC-U cement spigots PP/PVDF fusion spigots	L: PVDF-HP/PP butt fusion spigots BCF/IR
16	10	70	100	130	134	-
20	15	70	100	130	134	150
25	20	100	134	180	174	190
32	25	100	134	180	174	190
40	32	130	175	230	224	240
50	40	130	175	230	224	240

da	DN	PVC-U, PP/PVDF			Weight (kg) - PVC-U			PP	PVDF
		L1	L2		L	L1	L2	L	L
16	10	154	140		0.68	0.73	0.84	0.55	0.79
20	15	154	140		0.68	0.76	0.88	0.51	0.78
25	20	185	180		1.35	1.49	1.64	1.03	1.62
32	25	185	180		1.63	1.56	1.75	1.02	1.59
40	32	248	230		2.96	3.32	3.62	2.24	5.32
50	40	252	230		2.96	3.38	3.74	2.24	5.32

Cement and fusion spigots according to DIN/ISO

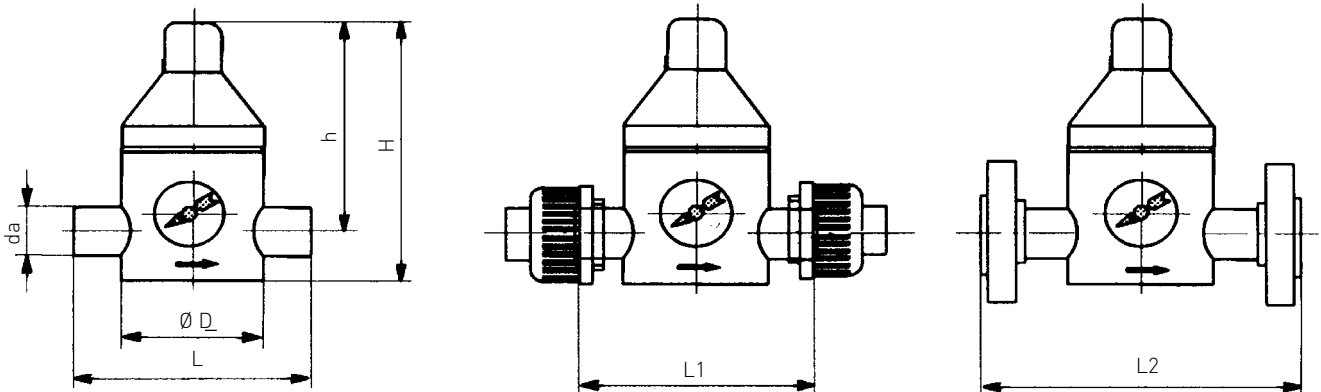

Characteristics V182

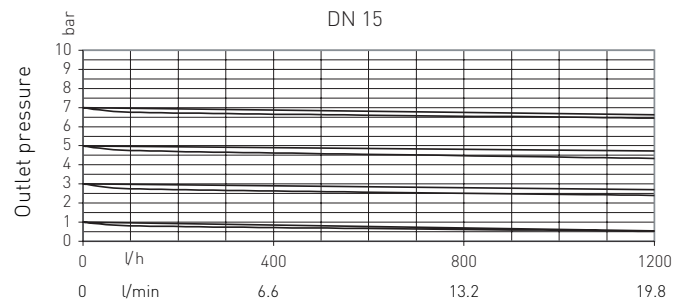
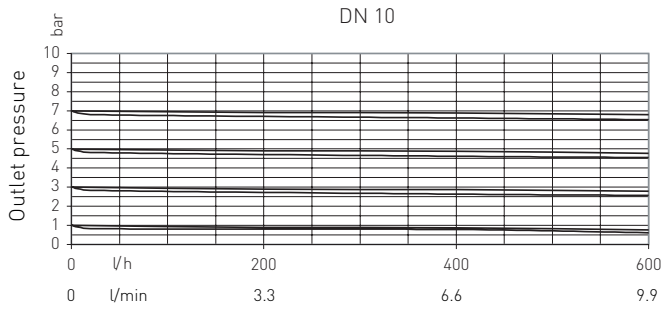

Characteristics valid for 2 m/s

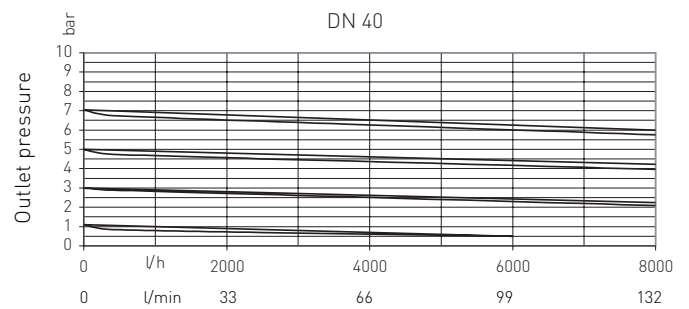
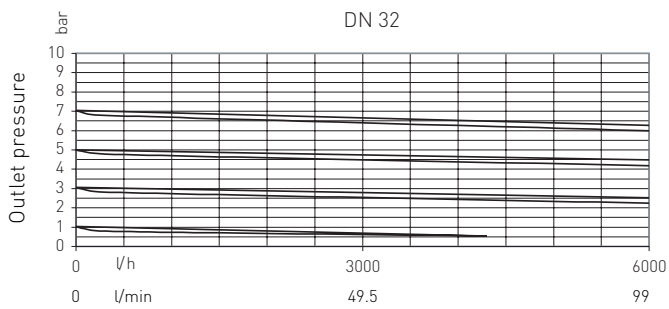
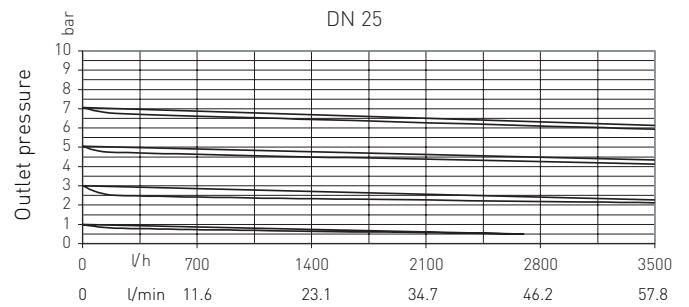
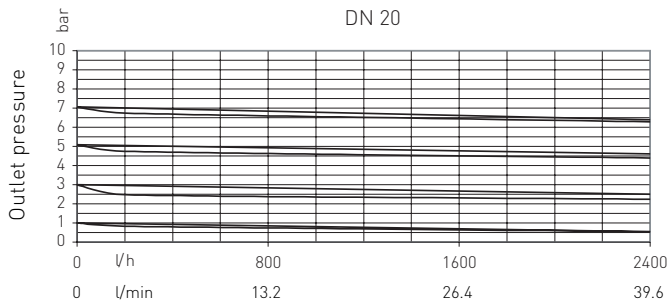

Order number

DN	d	Adj. range in bar	PVC-U		PP		PP/IR-spigots		PVDF-FPM	HP-Version*
			EPDM	FPM	EPDM	FPM	EPDM	FPM	Standard	BCF/IR spigots
10	16	0.5 - 9.0	199 041 600	199 041 611	199 041 621	199 041 631	199 041 641	199 041 651	199 041 661	199 041 671
15	20	0.5 - 9.0	199 041 601	199 041 612	199 041 622	199 041 632	199 041 642	199 041 652	199 041 662	199 041 672
20	25	0.5 - 9.0	199 041 602	199 041 613	199 041 623	199 041 633	199 041 643	199 041 653	199 041 663	199 041 673
25	32	0.5 - 9.0	199 041 603	199 041 614	199 041 624	199 041 634	199 041 644	199 041 654	199 041 664	199 041 674
32	40	0.5 - 9.0	199 041 604	199 041 615	199 041 625	199 041 635	199 041 645	199 041 655	199 041 665	199 041 675
40	50	0.5 - 9.0	199 041 605	199 041 616	199 041 626	199 041 636	199 041 646	199 041 656	199 041 666	199 041 676

* BCF fusion only possible up to DN 50

PVDF - PTFE Standard with IR spigots on request

- in preparation

Flange and union versions on request

Sectional drawing V182

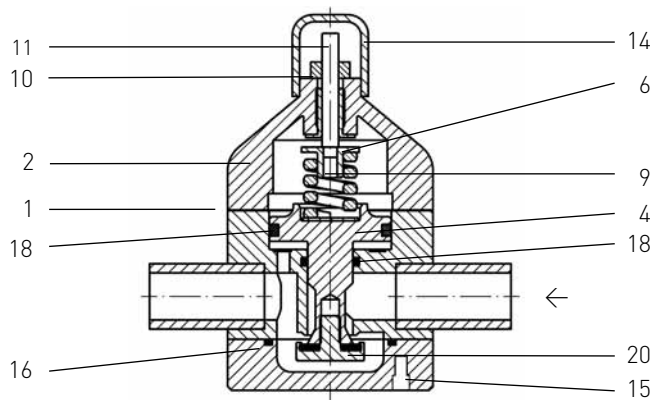

shown without pressure gauge

Parts

No.	Description
1.	Valve body
2.	Upper valve body
4.*	Piston
6.	Spring plate
9.*	Compression spring
10.	Lock nut
11.	Adjusting screw
14.	Cap
15.	Hexagonal socket-head bolt
16.	Valve bottom with O-ring
18.*	O-ring
20.	Piston base

* Parts subject to wear or recommended spare parts

Installation and operating advice

- Note the direction of flow! Indicated by the arrow on the valve.
- We recommend fitting the valve between 2 detachable pipe connections (flanges or screw fastenings).
- Can be installed in any position with no effect on functioning.
- Where the medium is dirty or particle-laden, we recommend installing a strainer to avoid any breakdowns.

Dismantling instructions

1. Dismantling the valve upper/lower body:
 - 1.1 Put the valve in an upright position
 - 1.2 Unscrew the cap (14)
 - 1.3 Undo the locknut on the adjusting screw (11) and undo the adjusting screw until the compression spring (9) is fully released
 - 1.4 Undo the screws (15)
 - 1.5 Lift the upper body (2) upwards and remove the spring plate (6) and the spring (9)

These steps are carried out in reverse order to reassemble!

Operating faults and possible causes

Fault	Cause	Correction
Medium leaks from adjusting screw	Defective O-ring (17)	Replace O-ring (17)
Pressure exceeds set value	Leaky O-ring (18)	Replace O-ring (18)
	Control bores in housing soiled	Unscrew bottom part of piston, clean holes, if necessary dismount piston
Valve closed – does not open	Installed wrong way around	Turn valve around, see arrow for flow direction
Leakage between valve body and base	Leaky O-ring (16)	Dismantle valve base and replace O-ring

Installation tip:

We recommend fitting the valve between 2 detachable pipe connections.

Pressure Retaining Valve V786



General

Function

The V786 Pressure Retaining Valve serves to keep the working or system-related pressures constant, to balance out pressure pulsation and to reduce pressure peaks in chemical process systems. If the inlet pressure rises above the set value, the pressurized valve piston is lifted against the spring force. Consequently, the valve opens and there is a reduction of pressure in the outlet pipe. The valve closes as soon as the inlet pressure sinks below the pre-set spring tension.

The wide range of materials available for the housings (PVC-U, PP, PVDF) and the diaphragms (EPDM, EPDM-PTFE-coated) cover many areas of application for technically pure, neutral and aggressive fluids as well as ultra-pure water applications. For more information, please refer to the Georg Fischer Piping Systems List of Resistance. We recommend installing a strainer upstream to avoid any breakdowns.

Special features

- All parts in contact with the medium are made of highly resistant plastics.
- The actuator is separated and hermetically sealed off from the flow section by the control diaphragm.
- The working pressure is set with an adjusting screw and locked with a locknut.
- The streamlined design of the housing makes for good flow rates.
- The large control surface and the spiral spring keep standard tolerances small.
- No auxiliary energy is required to operate the valve.
- The valve is largely maintenance-free and can be installed in any position.
- Valve can also be adjusted under working pressure.

Technical data V786

Available materials

Valve housing: PVC-U, PP, PVDF
 Diaphragm: EPDM, EPDM-PTFE-coated
 Pressure range: DN 10–DN 25: 0.5–10 bar
 DN 32–DN 40: 0.5–4 bar

Allowable working temperature

PVC-U 0 to + 60 °C
 PP -10 to + 80 °C
 PVDF -40 to + 100 °C

Working pressure

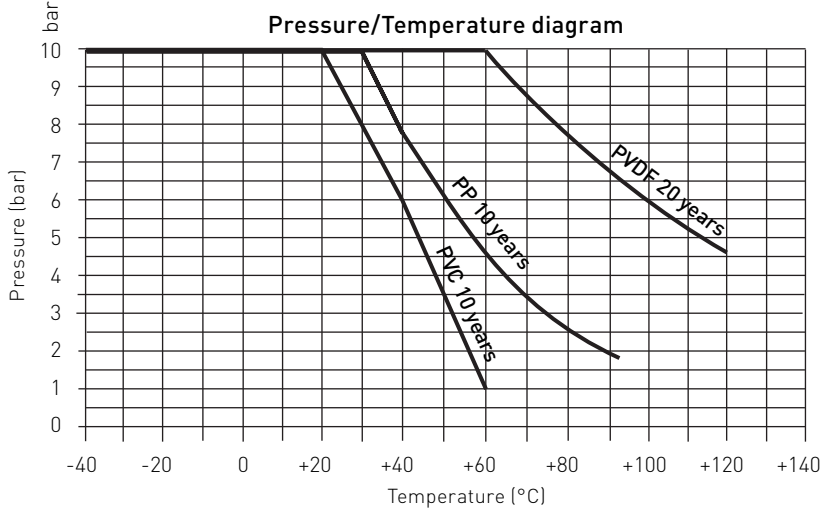

Adjustment range for working pressure upstream of the valve

DN 10–DN 25: 0.5 to 10 bar
 DN 32–DN 40: 0.5 to 4 bar

Alternative DN 32–DN 40:

For pressures **greater than 4 bar**, the **pressure retaining valve V186** can be used.

Dimensions and weight V786

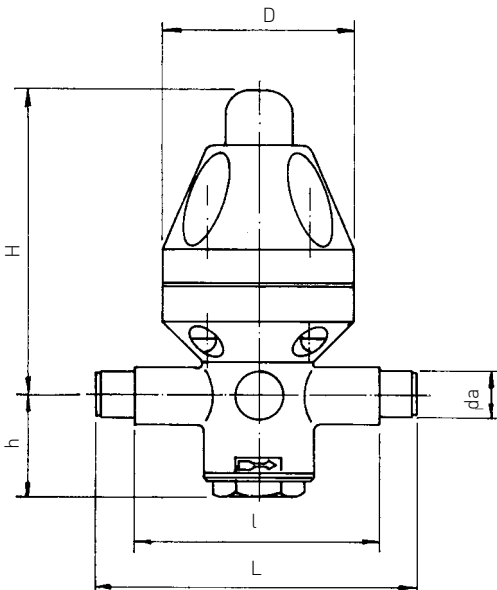

da	DN	L: PVC-U cement spigots PP/PVDF fusion spigots	L: PVDF-HP/PP butt fusion spigots BCF/IR	l	H	h	D
16	10	134	-	102	138	38	83
20	15	134	172	102	138	38	83
25	20	154	190	110	205	55	112
32	25	154	190	110	205	55	112
40	32	224	262	162	248	85	165
50	40	224	262	162	248	85	165

da	DN	Weight (kg) PVC-U	PP	PVDF
16	10	0.62	0.45	0.64
20	15	0.62	0.45	0.68
25	20	1.70	1.28	1.89
32	25	1.70	1.28	1.91
40	32	4.84	3.48	6.30
50	40	4.84	3.46	6.24

Cement and fusion spigots according to DIN/ISO

The valve characteristics diagram shows the primary or working pressure p_A in bar in relation to the flow rate Q in l/hr.

The parameter is the set pressure p_E at $Q = 0$ l/hr. The curve indicates the opening pressure progression. The characteristics apply to water at +20 °C.

Working pressure
Opening pressure
Closing pressure

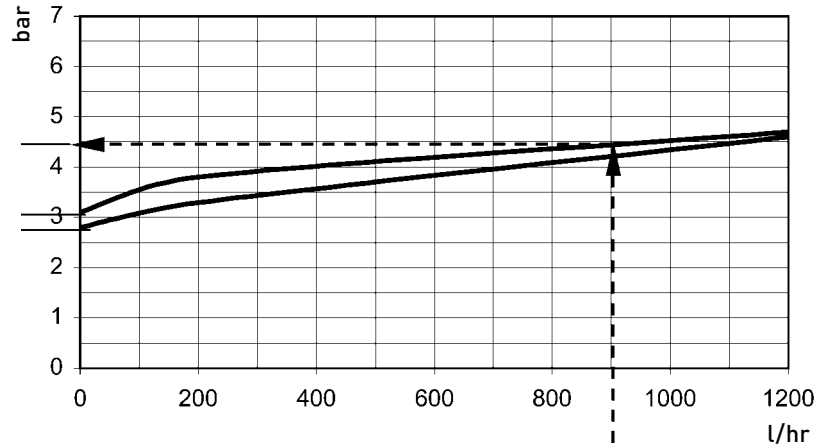

Example:

A valve XY is adjusted at 3 bar. If the flow is increased to 900 l/hr, the input pressure increases to 4.5 bar. According to the characteristics, the following values apply:

- Working pressure approx. 4.5 bar
- Opening pressure approx. 3.1 bar
- Closing pressure approx. 2.8 bar

Installation examples for pressure retaining valves:

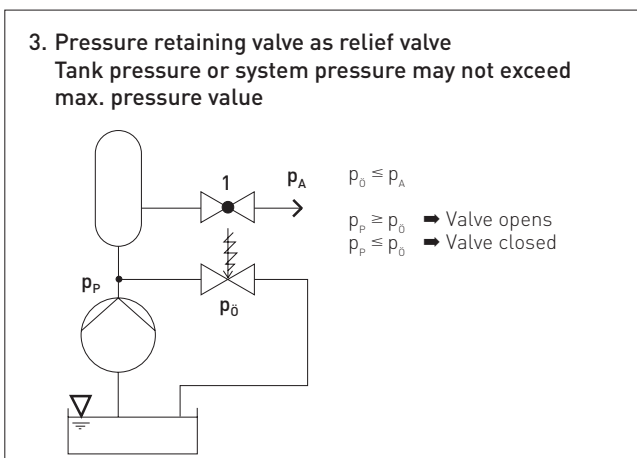
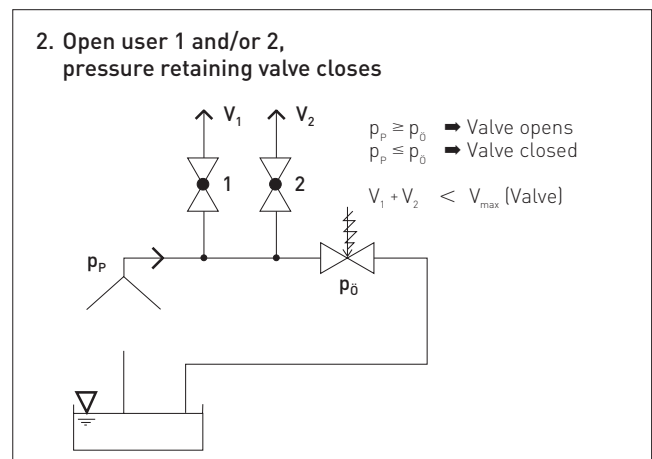
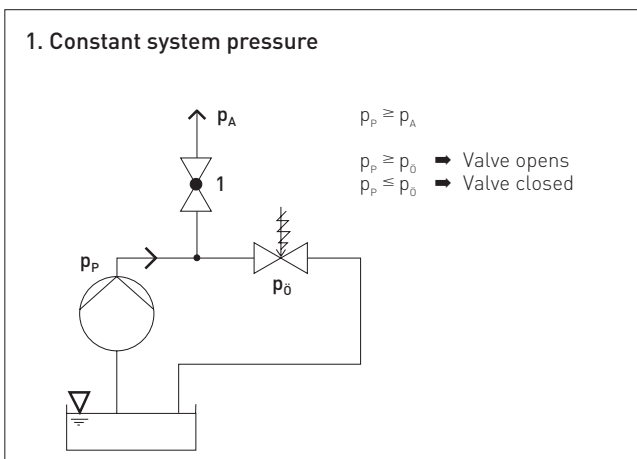

p_A = working pressure
 p_P = pump pressure
 p_0 = opening pressure

Characteristics V786

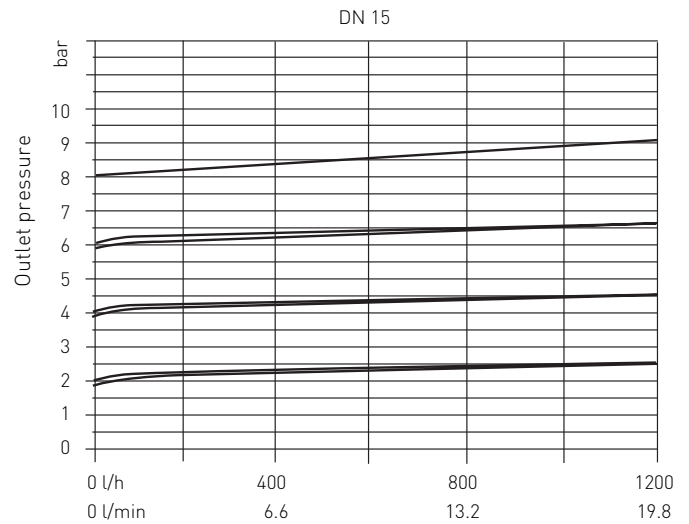
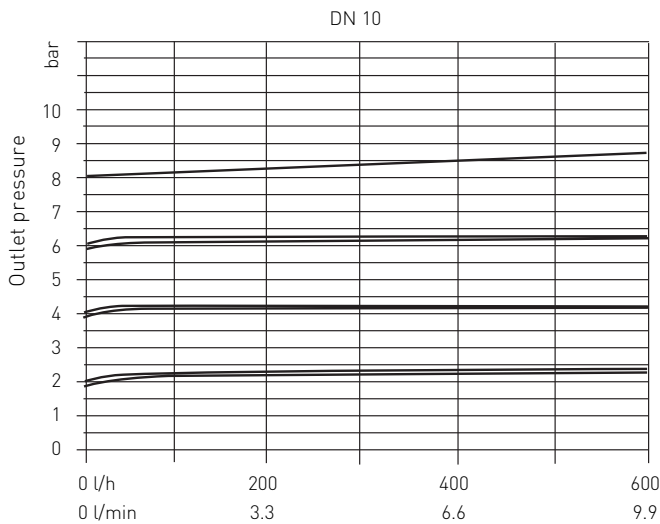

Characteristics are valid for a flow rate of 2 m/s

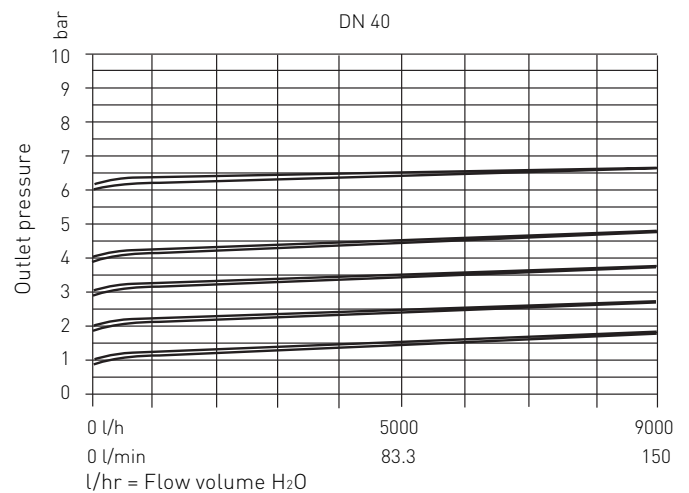
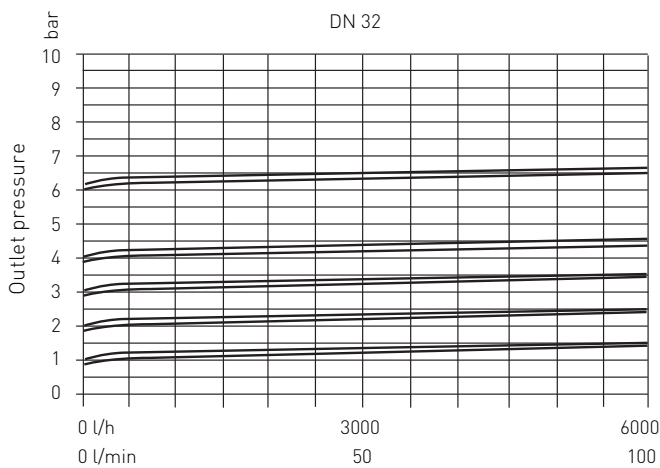
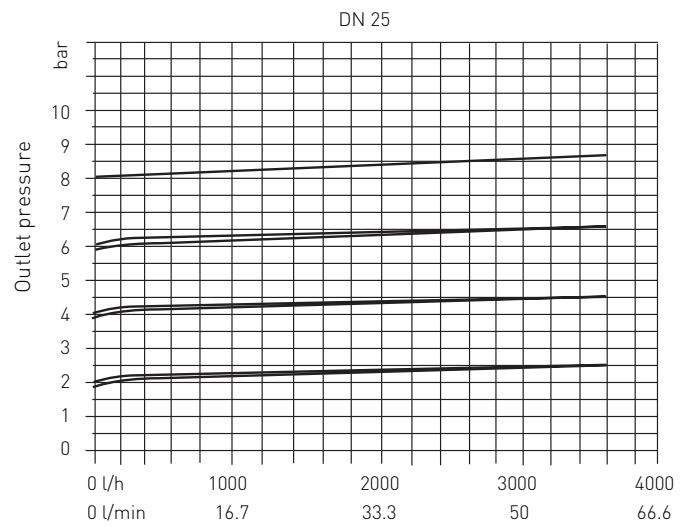
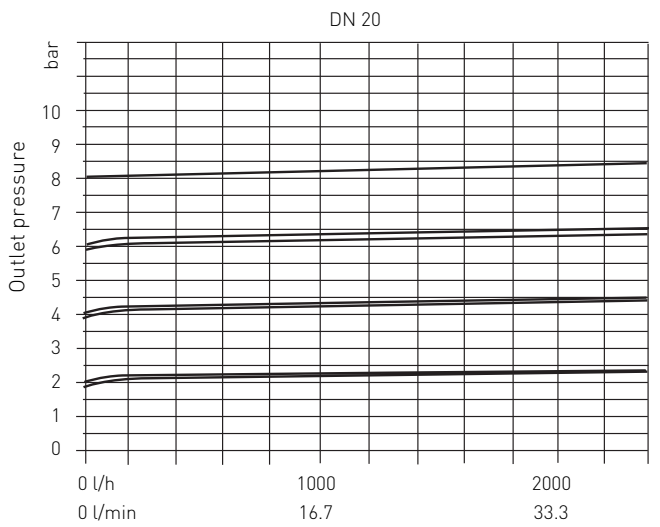

Order number

DN	da	Adj. range in bar	PVC-U		PP		PP/IR spigots		PVDF-PTFE Standard	HP Version* BCF/IR spigots
			EPDM	PTFE	EPDM	PTFE	EPDM	PTFE		
110	16	0.5 - 9	199 041 090	199 041 096	199 041 102	199 041 108	-	-	199 041 114	-
15	20	0.5 - 9	199 041 091	199 041 097	199 041 103	199 041 109	199 041 431	199 041 437	199 041 115	199 041 198
20	25	0.5 - 9	199 041 092	199 041 098	199 041 104	199 041 110	199 041 432	199 041 438	199 041 116	199 041 199
25	32	0.5 - 9	199 041 093	199 041 099	199 041 105	199 041 111	199 041 433	199 041 439	199 041 117	199 041 200
32	40	0.5 - 4	199 041 094	199 041 100	199 041 106	199 041 112	199 041 434	199 041 440	199 041 118	199 041 201
40	50	0.5 - 4	199 041 095	199 041 101	199 041 107	199 041 113	199 041 435	199 041 441	199 041 119	199 041 202

* PVDF - PTFE Standard with IR spigots on request. Flange and union versions on request

Sectional drawing V786

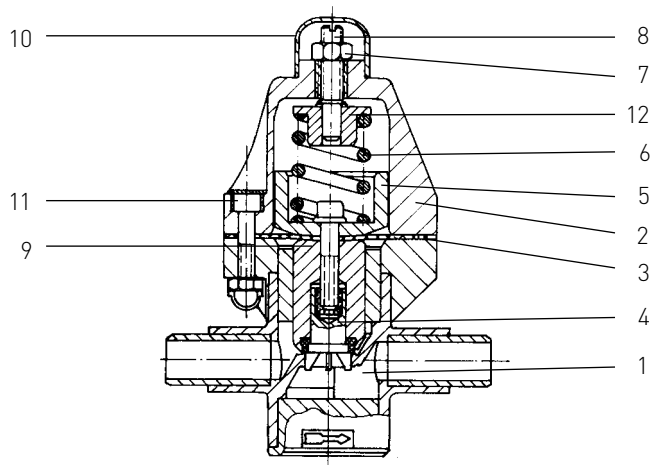

Parts

No.	Description
1.	Valve body
2.	Upper valve body
3.*	Diaphragm
4.*	Piston
5.	Compressor
6.*	Compression spring
7.	Lock nut
8.	Adjusting screw
9.	Cylinder screw
10.	Cap
11.	Hexagonal socket-head bolt with nut and covering cup
12.	Spring plate

* Parts subject to wear or recommended spare parts

Assembly instructions

1. Dismantle the upper valve body:
 - 1.1 Put the valve in an upright position
 - 1.2 Unscrew the cap (14)
 - 1.3 Undo the locknut (7) on the adjusting screw (8) and undo the adjusting screw until the compression spring (6) is fully released
 - 1.4 Remove the covering caps on the screws (11) of the upper body and undo the screws
 - 1.5 Lift the upper body (2) upwards and remove the spring plate (12) and the spring (6)
2. Dismantle the lower valve body and the diaphragm:
 - 2.1 Carry out steps 1.1 to 1.5
 - 2.2 Remove the complete piston (4) with the diaphragm (3) and the pressure plate (5) from the lower valve body (1)
 - 2.3 Clamp the piston in a vice so that the diaphragm is on top
 - 2.4 Undo the screw (9) and remove the pressure plate with the diaphragm

These steps are carried out in reverse order to reassemble!

Please see individual parts for positions and assembly diagrams!

Operating faults and possible causes

Fault	Cause	Correction
Valve not sealed at the diaphragm	Diaphragm not pressed on hard enough	Tighten screws (10)
Pressure falls below the set value	Piston base (2) not sealed	Check piston and piston base seal and possibly replace. Dismantle lower body 1.1-2.4
	Diaphragm (3) not sealed	Replace diaphragm, dismantle lower valve body 1.1-2.4
Medium leaks out at the adjusting screw	Diaphragm is faulty	Replace diaphragm, dismantle lower valve body 1.1-2.4

Installation advice:

We recommend installing the fittings between 2 detachable pipe connections.

Pressure Retaining Valve V186/V86



General

Function

The V186/V86 Pressure Retaining Valve serves to keep the working or system-related pressures constant, to balance out pressure pulsation and to reduce pressure peaks in chemical process systems. If the inlet pressure rises above the set value, the pressurized valve piston is lifted against the spring force. Consequently, the valve opens and there is a reduction of pressure in the outlet pipe. The valve closes as soon as the inlet pressure sinks below the pre-set spring tension.

When used as a bypass, it can also function as a relief valve to reduce pressure peaks. Due to the zero static design of the lower part, the valve is also suitable for use in ultra-pure water applications, as well as for technically pure, neutral and aggressive fluids. For more information, please consult the Georg Fischer Piping Systems List of Resistance.

Special features

- Compact construction
- Good control characteristics
- Low maintenance due to uncomplicated design
- Control unit is hermetically separated from flow medium by standard EPDM or EPDM-PTFE-coated diaphragm
- Zero static lower body (V186)
- Mounting position depends on flow direction
- Valve mounting with threaded insert on lower body
- Adjustment range: 0.5–9 bar
- Valve can also be adjusted under working pressure

Technical data V186/V86

Available materials

Valve housing: PVC-U, PP, PVDF
 Diaphragm: EPDM,
 EPDM-PTFE-coated

Pressure ranges:

DN 10–50 0.5–10 bar Series V186
 DN 65–80 1.0–6 bar Series V86
 DN 100 1.0–4 bar Series V86

Connections

Cement or fusion spigot according to ISO/DIN.
 Available with union or flange on request.

Allowable working temperature

PVC 0 to + 60 °C
 PP –10 to + 80 °C
 PVDF –20 to + 100 °C

Dimensions and weight V186/V86

DN	L: PVC-U cement spigots PP/PVDF fusion spigots		PVDF-HP/PP butt fusion spigots BCF/IR	L1	L2	Ø D	h
10	134		–	140	154	83	20
15/20	134		158	140	154	83	20
25	174		198	180	185	112	27
32	174		202	230	248	165	43
40	224		256	230	248	165	43
50	244		256	250	252	165	43
65	284		284	290	280	180	230
80	360		360	310	–	250	320
100	380		380	390	–	250	415

DN	H	Weight PVC-U (kg)	Weight PP (kg)	Weight PVDF (kg)
10	137	0.4	0.3	0.6
15/20	137	0.4	0.3	0.6
25	199	1.2	0.9	1.6
32	199	1.2	0.9	1.6
40	290	6.4	4.4	8.0
50	290	6.5	4.5	8.2
65	275	7.7	5.9	8.6
80	410	17.7	12.9	22.3
100	485	19.6	14.5	24.6

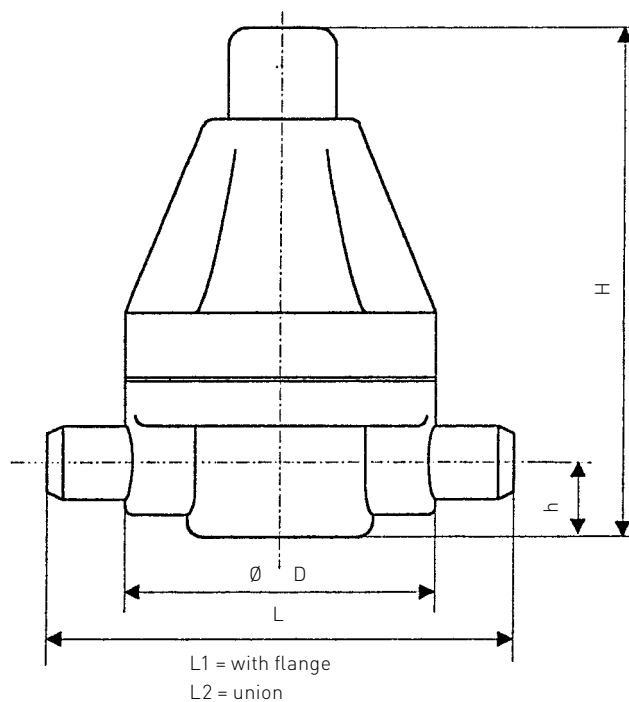

Characteristics V186

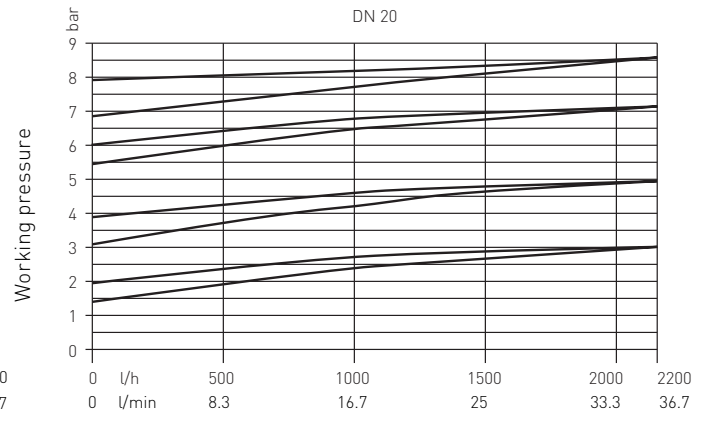
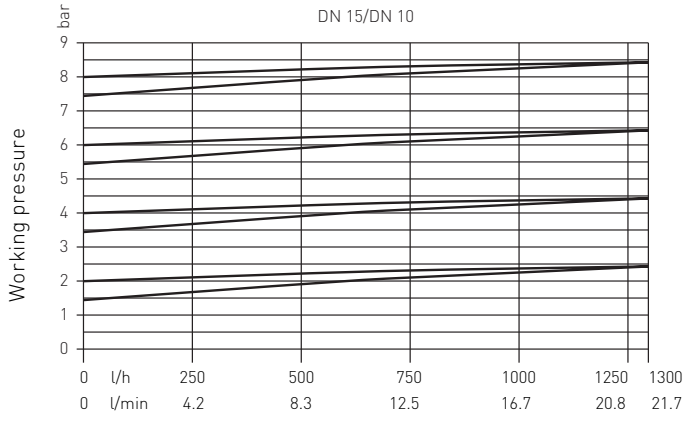

Characteristics are valid for a flow rate of 2 m/s

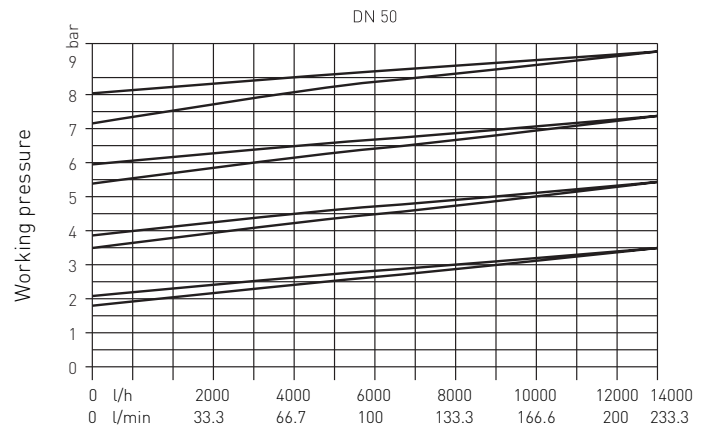
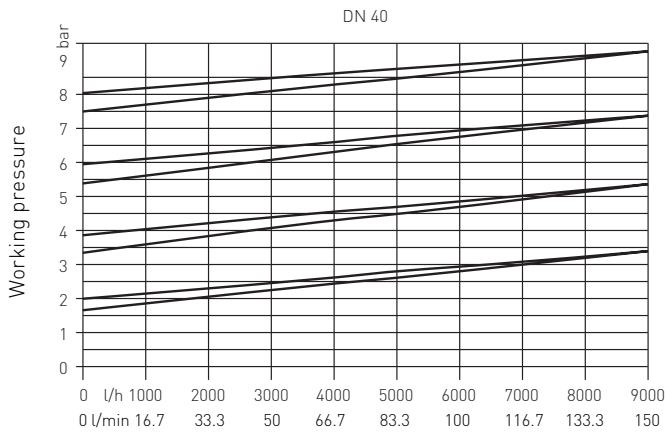
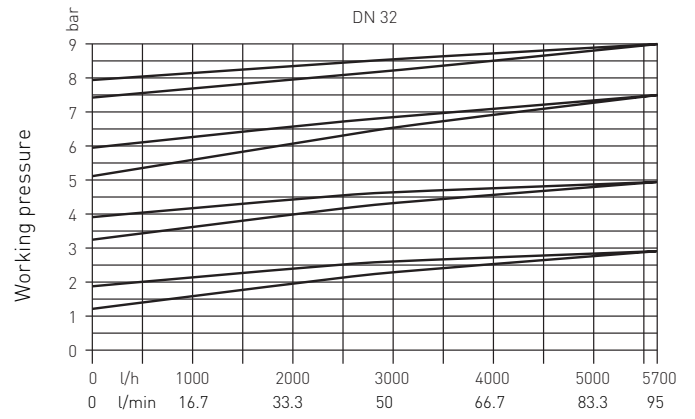
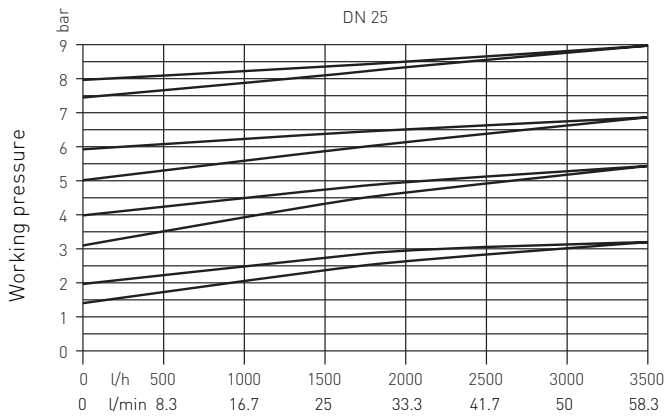

l/hr = Flow volume H₂O

Characteristics V86

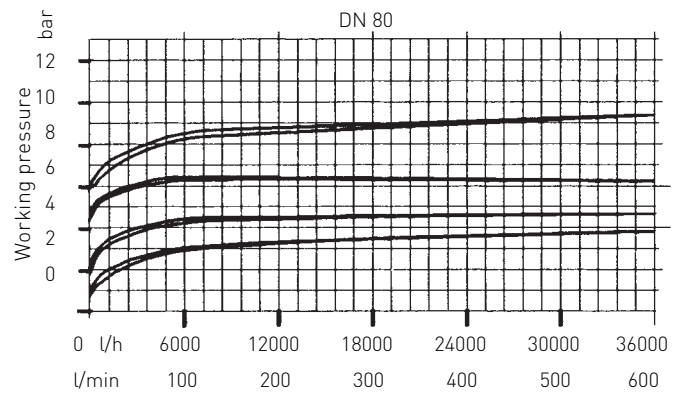
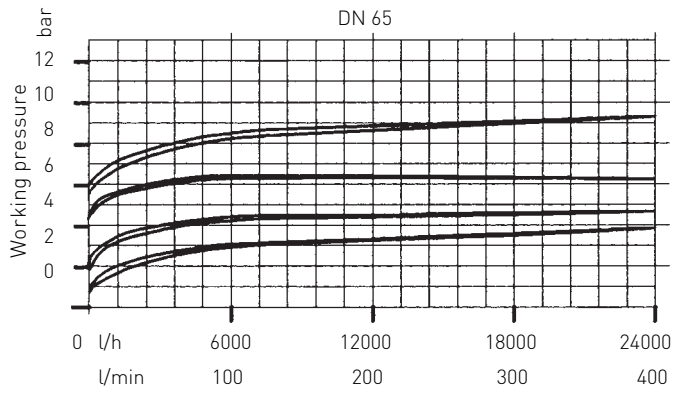

Characteristics are valid for a flow rate of 2 m/s

l/hr. l/min = flow volume H₂O

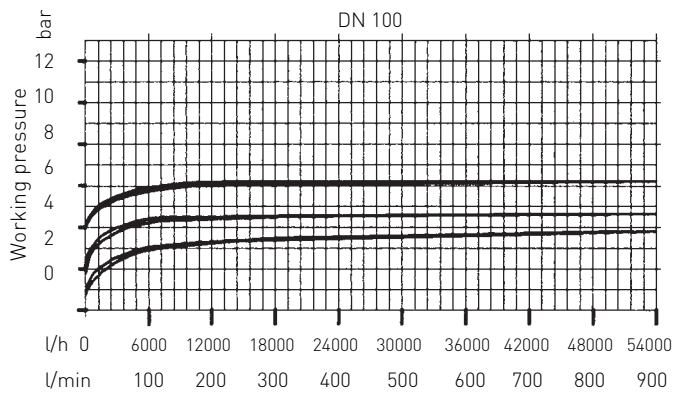

Order number

DN	d	Adj. range in bar	PVC-U		PP		PP/IR spigots		PVDF-PTFE Standard	PVDF-HPVersion* BCF/IR spigots
			EPDM	PTFE	EPDM	PTFE	EPDM	PTFE		
10	16	0.5 - 9.0	199 041 379	199 041 309	199 041 386	199 041 316	-	-	199 041 323	-
15	20	0.5 - 9.0	199 041 380	199 041 310	199 041 387	199 041 317	199 041 446	199 041 453	199 041 324	199 041 395
20	25	0.5 - 9.0	199 041 381	199 041 311	199 041 388	199 041 318	199 041 447	199 041 454	199 041 325	199 041 396
25	32	0.5 - 9.0	199 041 382	199 041 312	199 041 389	199 041 319	199 041 448	199 041 455	199 041 326	199 041 397
32	40	0.5 - 9.0	199 041 383	199 041 313	199 041 390	199 041 320	199 041 449	199 041 456	199 041 327	199 041 398
40	50	0.5 - 9.0	199 041 384	199 041 314	199 041 391	199 041 321	199 041 450	199 041 457	199 041 328	199 041 399
50	63	0.5 - 9.0	199 041 385	199 041 315	199 041 392	199 041 322	199 041 451	199 041 458	199 041 329	199 041 400
65	75	0.5 - 4.0	199 041 922	199 041 989	199 041 882	199 041 887	199 041 470	199 041 475	-	-
65	75	1.0 - 6.0	199 041 950	199 041 990	199 041 883	199 041 888	199 041 471	199 041 476	199 041 892	199 041 481
80	90	0.5 - 4.0	199 041 987	199 041 944	199 041 884	199 041 889	199 041 472	199 041 477	-	-
80	90	1.0 - 6.0	199 041 988	199 041 991	199 041 885	199 041 890	199 041 473	199 041 478	-	-
100	110	1.0 - 4.0	199 041 953	199 041 945	199 041 886	199 041 891	199 041 474	199 041 479	-	-

* BCF fusion only possible up to DN 50 possible

PVDF - PTFE Standard with IR spigots on request

Flange and union versions on request

Sectional drawing V186 DN 10–DN 50

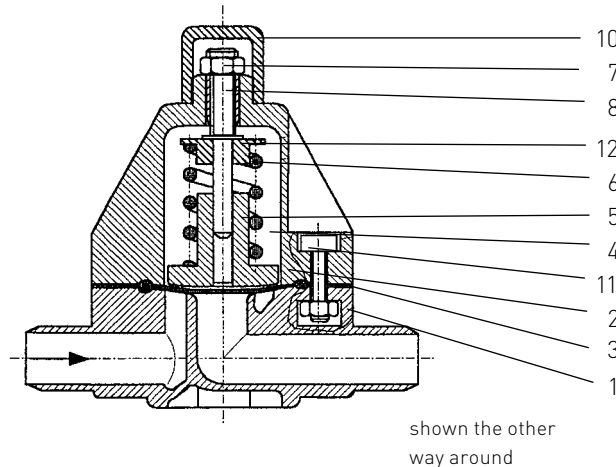

Parts V86/V186

No.	Description
1.	Valve body
2.	Upper valve body
3.*	Diaphragm
4.*	Piston
5.	Compressor
6.*	Compression spring
7.	Lock nut
8.	Adjusting screw
9.	Cylinder screw
10.	Cap
11.	Hexagonal socket-head bolt with nut and covering cup
12.	Spring plate

* Parts subject to wear or recommended spare parts

Pressure retaining valve V86 DN 65–DN 100

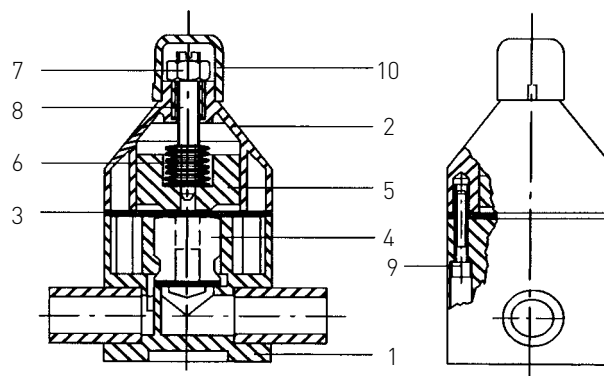

Dismantling instructions

1. Dismantle the upper valve body:
 - 1.1 Put the valve in an upright position
 - 1.2 Unscrew the cap (14)
 - 1.3 Undo the locknut (7) on the adjusting screw (8) and undo the adjusting screw until the compression spring (6) is fully released
 - 1.4 Remove the covering caps on the screws (11) of the upper body and undo the screws
 - 1.5 Lift the upper body (2) upwards and remove the spring plate (12) and the spring (6)

Assembly is done in the reverse order!

Operating faults and possible causes

Fault	Cause	Correction
Valve not sealed at the diaphragm	Diaphragm not pressed on hard enough	Tighten screws (10)
Pressure falls below the set value	Piston base (2) not sealed	Check piston and piston base seal and possibly replace. Dismantle lower body 1.1-2.4
	Diaphragm (3) not sealed	Replace diaphragm, dismantle lower valve body 1.1-2.4
Medium leaks out at the adjusting screw	Diaphragm is faulty	Replace diaphragm, dismantle lower valve body 1.1-2.4

Installation advice:

We recommend installing the fittings between 2 detachable pipe connections.

Pressure Relief Valve V185/V85



General

Function

The V185/V85 Pressure Relief Valve serves to keep the working or system-related pressures constant, to balance out pressure pulsation and to reduce pressure peaks in chemical process systems. The third pipe spigot fitted on the valve body means the valve can be installed directly in the main pipeline. If the inlet pressure rises above the set value, the pressurized valve piston is lifted against the spring force. Consequently, the valve opens and there is a reduction of pressure in the outlet pipe. The valve closes as soon as the inlet pressure sinks below the pre-set spring tension.

Special features

- Compact construction
- Good control characteristics
- Low maintenance due to uncomplicated design
- Control unit is hermetically separated from flow medium by standard EPDM or EPDM-PTFE-coated diaphragm
- Zero static lower body (V185)
- Note the direction of flow! Indicated by the arrow on the valve
- Valve mounting with threaded insert on lower body (V185)
- Adjustment range: 0.5–9 bar (1–4 bar)

Technical Data V185/V85

Available materials

Valve housing: PVC-U, PP, PVDF
 Diaphragm: EPDM,
 EPDM-PTFE-coated

Pressure ranges:

DN 10–50 0.5–10 bar Series V185
 DN 65–80 1–6 bar Series V85
 DN 100 1–4 bar Series V85

Connection

Cement or fusion spigots according to ISO/DIN.
 Available with union or flanges on request.

Allowable working temperature

PVC 0 to + 60 °C
 PP –10 to + 80 °C
 PVDF –20 to + 100 °C

Dimensions and Weight V185/V85

DN	L: PVC-U cement spigots PP/PVDF fusion spigots	L: PVDF-HP/PP butt fusion spigots BCF/IR	L1	L2	Ø D	h
10	134	–	140	154	83	20
15/20	134	158	140	154	83	20
25	174	198	180	185	112	27
32	174	202	230	248	165	43
40	224	256	230	248	165	43
50	244	256	250	252	165	43
65	284	284	290	280	180	45
80	300	300	310	–	200	60
100	380	380	390	–	250	70

DN	H	Weight PVC-U (kg)	Weight PP (kg)	Weight PVDF (kg)
10	137	0.4	0.3	0.6
15/20	137	0.4	0.3	0.6
25	199	1.2	0.9	1.6
32	199	1.2	0.9	1.6
40	290	6.4	4.4	8.0
50	290	6.5	4.5	8.2
65	275	8.2	6.3	14.8
80	400	12.8	9.5	16.2
100	475	22.7	19.9	33.8

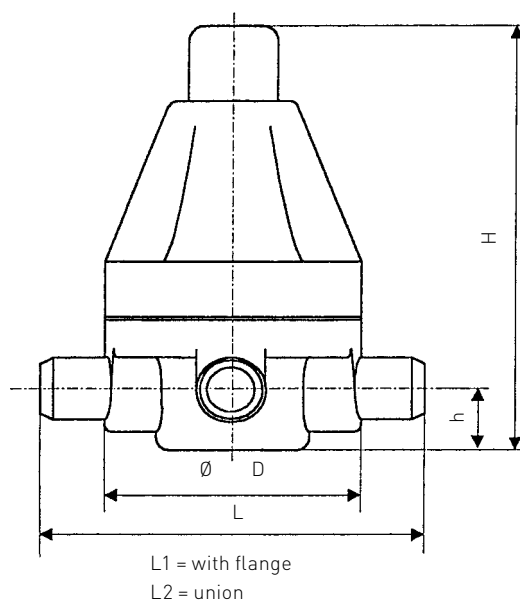

Sectional drawing V185 DN 15-DN 50

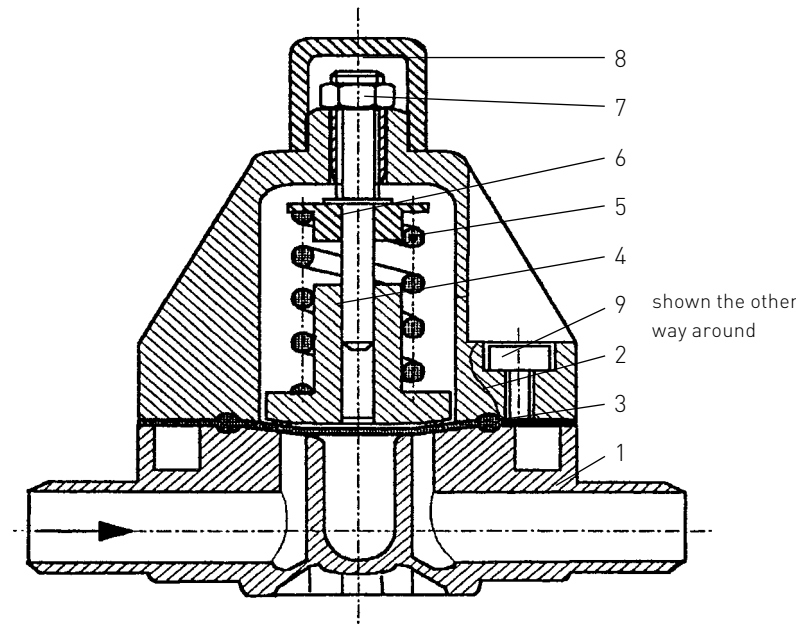

Parts V85/V185

No.	Description	Units
1.	Lower valve body	1
2.	Upper valve body	1
3.*	Diaphragm	1
4.	Pressure plate	1
5.*	Compression spring	1
6.	Spring plate	1
7.*	Adjusting screw with locknut	1
8.	Cap	1
9.	Connecting screws	4
10.*	Piston	1

* Parts subject to wear or recommended spare parts

Overflow valve V85 DN 65-DN 100

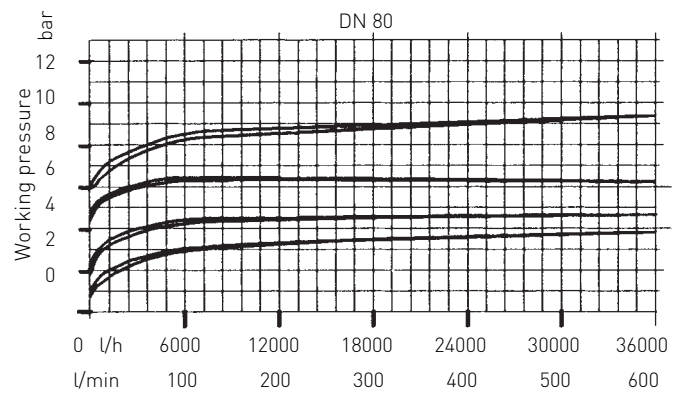
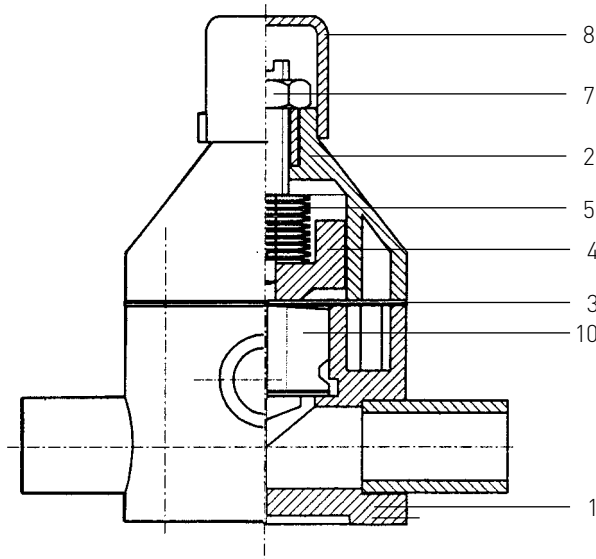

l/hr, l/min = flow volume H₂O

Characteristics V85

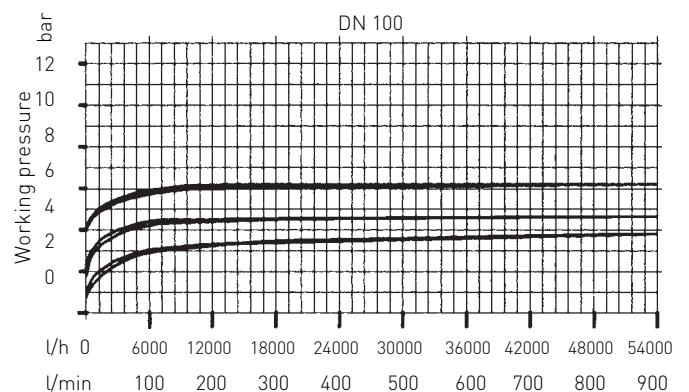
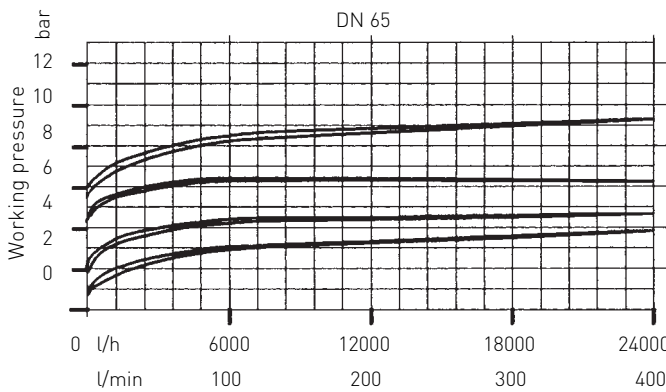

Characteristics are valid for a flow rate of 2 m/s

Characteristics V185

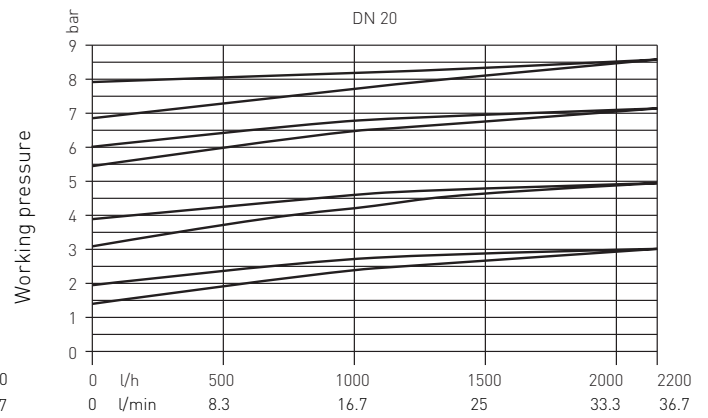
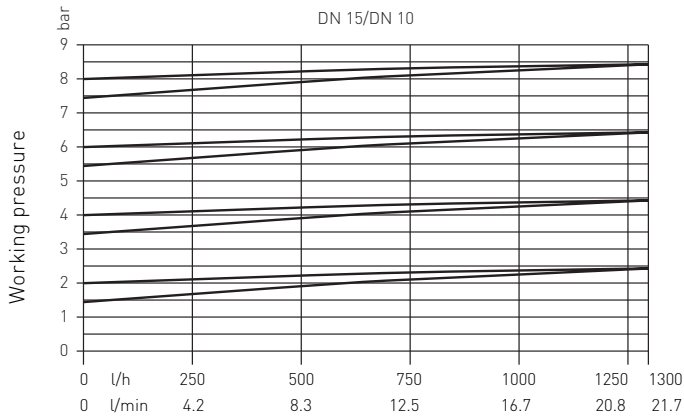

Characteristics are valid for a flow rate of 2 m/s

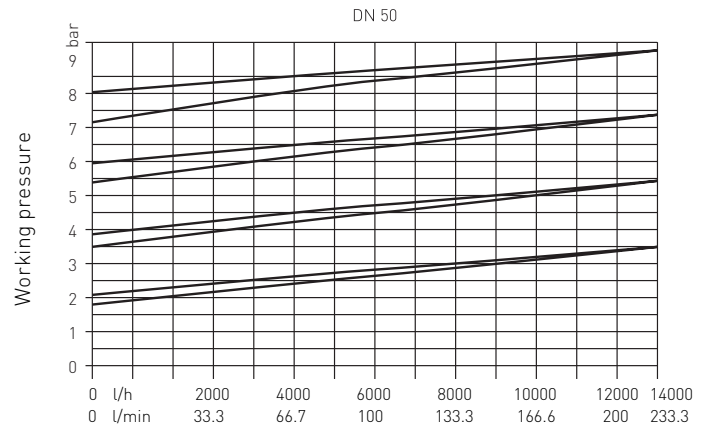
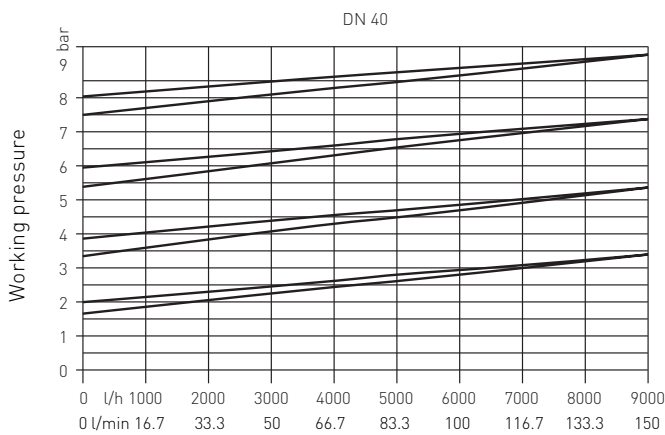
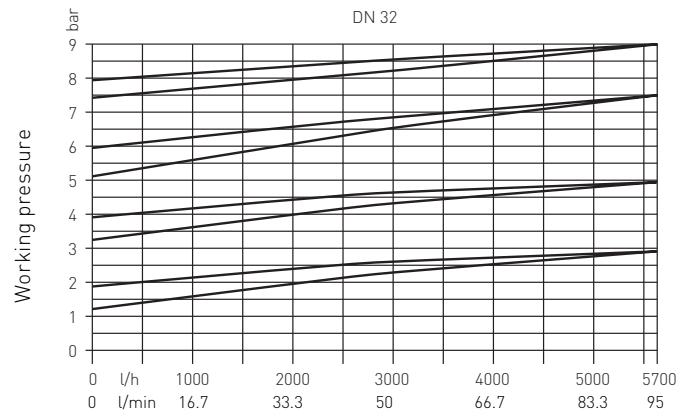
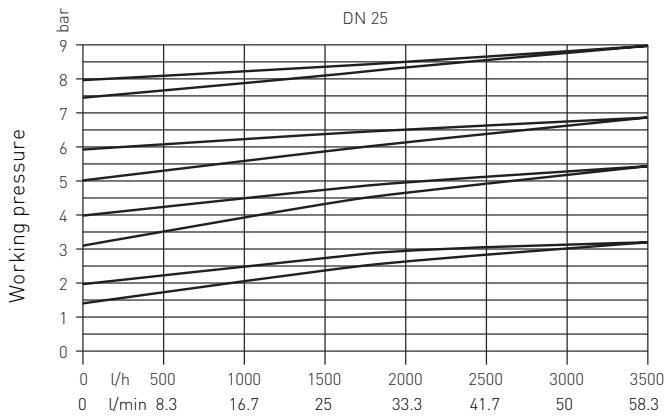

l/hr = Flow volume H₂O

Order number

DN	d	Adj. range in bar	PVC-U		PP		PP/IR spigots		PVDF-PTFE Standard	PVDF-HP Version* BCF/IR spigots
			EPDM	PTFE	EPDM	PTFE	EPDM	PTFE		
10	16	0.5 - 9	199 041 360	199 041 330	199 041 367	199 041 337	-	-	199 041 344	-
15	20	0.5 - 9	199 041 361	199 041 331	199 041 368	199 041 338	199 041 505	199 041 512	199 041 345	199 041 520
20	25	0.5 - 9	199 041 362	199 041 332	199 041 369	199 041 339	199 041 506	199 041 513	199 041 346	199 041 521
25	32	0.5 - 9	199 041 363	199 041 333	199 041 370	199 041 340	199 041 507	199 041 514	199 041 347	199 041 522
32	40	0.5 - 9	199 041 364	199 041 334	199 041 371	199 041 341	199 041 508	199 041 515	199 041 348	199 041 523
40	50	0.5 - 9	199 041 365	199 041 335	199 041 372	199 041 342	199 041 509	199 041 516	199 041 349	199 041 524
50	63	0.5 - 9	199 041 366	199 041 336	199 041 373	199 041 343	199 041 510	199 041 517	199 041 350	199 041 525
65	75	1 - 6	199 041 919	199 041 984	199 041 926	199 041 895	199 041 530	199 041 533	199 041 898	199 041 536
80	90	1 - 6	199 041 940	199 041 985	199 041 893	199 041 896	199 041 531	199 041 534	-	-
100	110	1 - 4	199 041 914	199 041 986	199 041 894	199 041 897	199 041 532	199 041 535	-	-

* BCF fusion only possible up to DN 50

PVDF - PTFE Standard with IR spigots on request

Diaphragm Gauge Guard Z700/Z701



General

Function

The diaphragm-protected gauge guard is used when measuring the pressure of neutral and corrosive media. The manometer is separated from the medium by a PTFE-coated diaphragm. The pressure is transmitted using a buffer fluid. The large area of the diaphragm and the low compressibility of the buffer fluid ensure an accurate display. The large number of possible materials make for a wide range of areas of application.

Special features

- All parts in contact with the medium are made of highly resistant plastics
- The manometer does not come into contact with the medium
- The diaphragm gauge guard is low-maintenance and can be installed in any position
- The large area of the diaphragm ensures accuracy

Technical data Z700

Available materials

Gauge guard housing: PVC-U, PP, PVDF
 Diaphragm: EPDM, EPDM-PTFE-coated

Allowable working temperature

PVC -0 to + 60 °C
 PP -10 to + 80 °C
 PVDF -20 to + 100 °C

Allowable working pressure for connection

PN 10 at 20 °C

Manometer connections

R 1/4"
 R 1/2"

Connection spigots

- da 25 with manometer connection Rp 1/4"
- da 32 with manometer connection Rp 1/2"
- selectable with NPT thread

Manometer ranges

Standard 0-10 bar, with Rp 1/4" Dm 63 mm, with Rp 1/2" Dm 100 mm, others on request

Accuracy

Standard class 2.5

Measuring range

0-10 bar
 0-6 bar

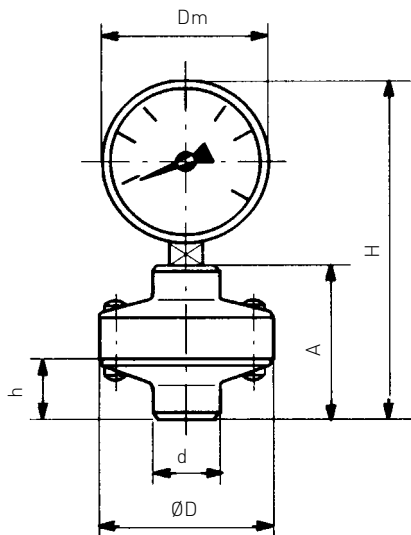

Dimensions and weight

Connection	da	Dm	H	h	A	ØD	Weight (kg)		
							PVC-U	PP	PVDF
R 1/4"	25	63	129	15	71	72	0.30	0.25	0.32
R 1/2"	32	100	210	22	90	100	0.60	0.54	0.68

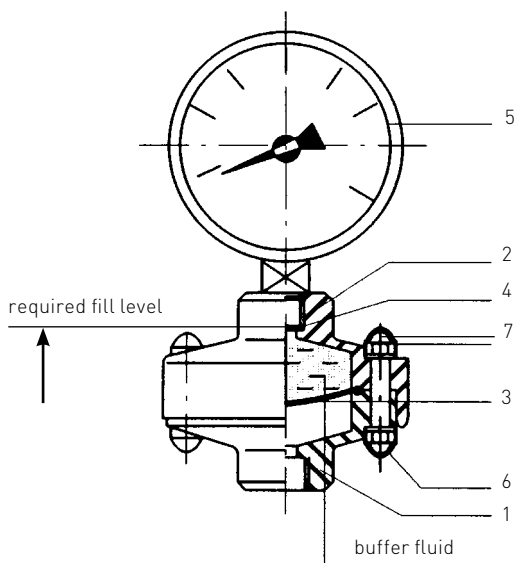

Parts

No.	Description	Units
1.	Flange	1
2.	Upper part	1
3.*	Diaphragm	1
4.	Manometer seal	1
5.	Monometer	1
6.	Hexagonal socket-head cap	12/16
7.	Hexagonal socket-head screw with washer and nut	6/8

* Parts subject to wear or recommended spare parts

Filling with buffer fluid

1. Fill the upper part (2) of the gauge guard Z700/Z701, preferably with Glystantin (anti-freeze solution) or water up to the bottom of the thread (see preceding page).
2. Gently press on the diaphragm from below with a blunt object until no more air bubbles come out.
3. Screw in the manometer. If the manometer already displays a pressure reading, some of the buffer fluid must be removed until there is no longer any display.

Installation advice

We recommend installing the gauge guard with a screw fastening and a shut-off device. That ensures that the manometer can be moved into the required position for reading even at a later stage, and can be easily replaced in the event of a fault.

Important

Sealing with a Teflon strip or with hemp can lead to the connection spigots tearing. We recommend fusing or cementing the connection spigots.

Order number

Z700 with 0–10 bar manometer

d mm	G inches	PVC-U	PP-H	PVDF
25	R 1/4"	199 041 000	199 041 002	199 041 004
32	R 1/2"	199 041 001	199 041 003	199 041 005

Order number

Z700 with 0–6 bar manometer

d mm	G inches	PVC-U	PP-H	PVDF
25	R 1/4"	199 041 292	199 041 294	199 041 296
32	R 1/2"	199 041 293	199 041 295	199 041 297

Order number

Z700 without manometer

d mm	G inches	PVC-U	PP-H	PVDF
25	R 1/4"	199 041 006	199 041 008	199 041 010
32	R 1/2"	199 041 007	199 041 009	199 041 011

Water Jet Suction Pump P20 DN 10 to DN 80



General

Application

Water jet fluid pumps can be used where pressurised fluid is available as a propellant. They are used for pumping out pits, moving and mixing chemical waste, adding acids or leaches in water treatment etc. They are self-priming and have no mechanically moving parts.

Because the P20 water jet suction pumps come in various materials, they can be used wherever the materials meet the given requirements.

Function

The basic principle of the water jet suction pump is that the propellant liquid passes through a nozzle and draws in with it the liquid or gaseous medium from the suction line, increasing its velocity. The result of this is that the propellant and the medium which is sucked in are mixed together. The amount of fluid propelled is a function of the propellant pressure and the size of the nozzle. The amount of liquid drawn in can be seen from the diagrams. The results shown are only guidelines and depend on the method of operation.

Versions

DN 10–DN 20 with external thread
DN 25–DN 50 with socket union
DN 65–DN 80 with spigot

Technical data P20

Available materials
PVC-U, PP, PVDF

Allowable working pressure
max. 10 bar at 20 °C

Allowable working temperature

PVC 0 to + 60 °C
PP -10 to + 80 °C
PVDF -20 to + 100 °C

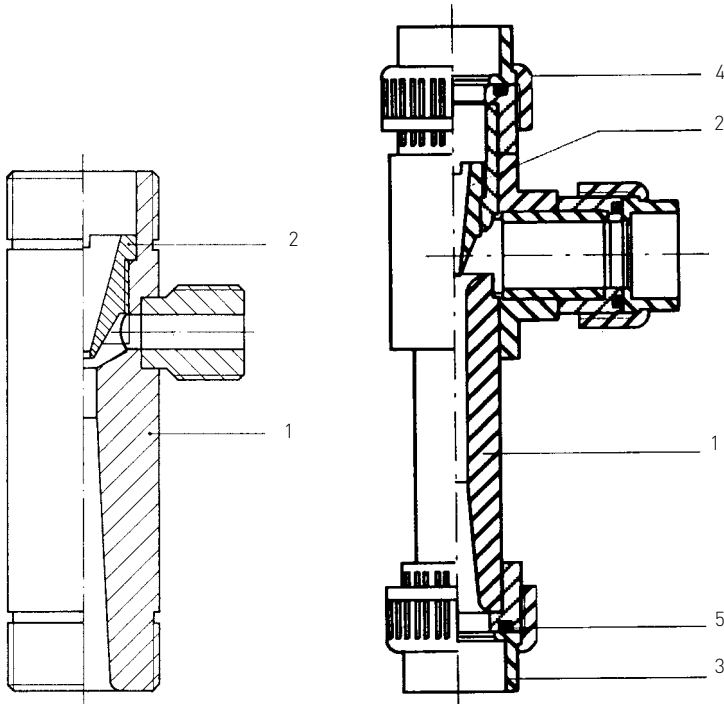

to DN 20

DN 25-DN 50

Parts

No.	Description	Units
1.	Water jet vacuum pump	1
2.	Nozzle	1
3.	Insert	3
4.	Union nut	3
5.	O-ring	3
6.	O-ring	3

Order number

DN	d	PN	PVC-U EPDM	PP EPDM	PVDF FPM	Weight (kgs)		
						PVC-U	PP	PVDF
10	16	10	199 041 120	199 041 129	199 041 138	0.14	0.10	0.35
15	20	10	199 041 121	199 041 130	199 041 139	0.22	0.17	0.40
20	25	10	199 041 122	199 041 131	199 041 140	0.40	0.27	0.48
25	32	10	199 041 123	199 041 132	199 041 141	0.48	0.40	0.69
32	40	10	199 041 124	199 041 133	199 041 142	0.87	0.69	0.80
40	50	10	199 041 125	199 041 134	199 041 143	1.38	1.08	1.88
50	63	10	199 041 126	199 041 135	199 041 144	2.45	1.93	3.34
65	75	10	199 041 127	199 041 136	199 041 145	2.35	1.51	3.80
80	90	10	199 041 128	199 041 137	199 041 146	4.09	2.57	6.50

The standard water jet suction pump P20 is delivered with the smallest nozzle in dependence on the dimension.

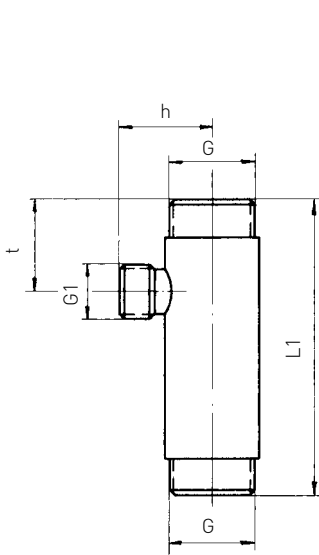

to DN 20

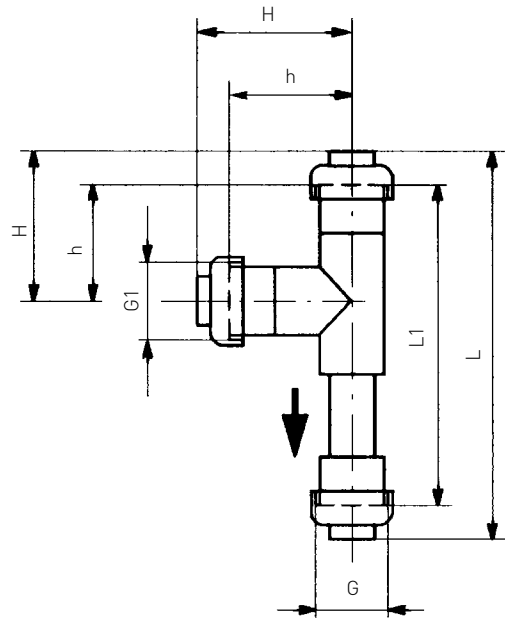

from DN 25-DN 50

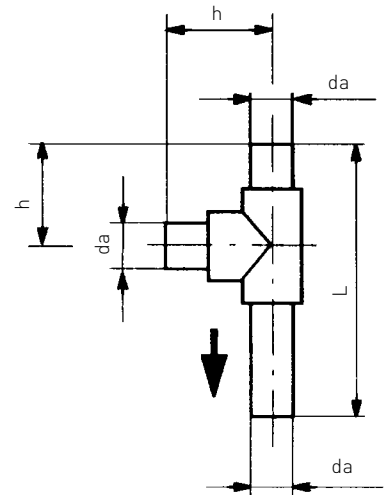

from DN 65

Dimensions

Type	da	DN	G	G1	L	L1	t	H	h
P 20.10 - 1.5	16	10	R 3/4"	R 3/4"	-	110	40	-	35
P 20.10 - 2.0									
P 20.15 - 2.0	20	15	R 1"	R 3/4"	-	125	40	-	35
P 20.15 - 3.0									
P 20.15 - 4.0									
P 20.20 - 3.0	25	20	R 1 1/4"	R 3/4"	-	145	45	-	45
P 20.20 - 4.5									
P 20.20 - 6.0									
P 20.25 - 2.5	32	25	R 1 1/2"	R 1 1/2"	245	195	-	96	71
P 20.25 - 4.0									
P 20.25 - 5.0									
P 20.32 - 3.0	40	32	R 2"	R 2"	297	239	-	116	87
P 20.32 - 4.5									
P 20.32 - 6.0									
P 20.40 - 3.5	50	40	R 2 1/4"	R 2 1/4"	369	301	-	139	105
P 20.40 - 5.5									
P 20.40 - 7.5									
P 20.50 - 5.0	63	50	R 2 3/4"	R 2 3/4"	433	351	-	169	128
P 20.50 - 7.0									
P 20.50 - 9.0									
P 20.65 - 6.5	75	65	-	-	388	-	-	-	115
P 20.65 - 9.0									
P 20.65 - 11.5									
P 20.80 - 8.0	90	80	-	-	465	-	-	-	149
P 20.80 - 11.0									
P 20.80 - 14.0									

Output diagram for water jet suction pump P 20.10

Suction medium: water

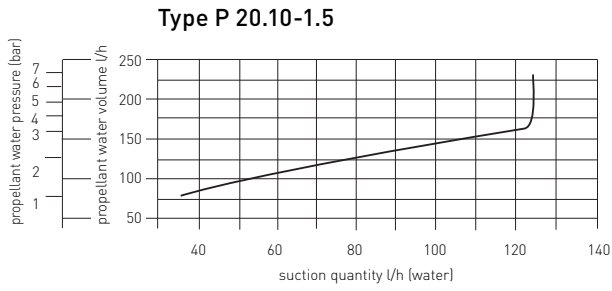

Suction medium: air

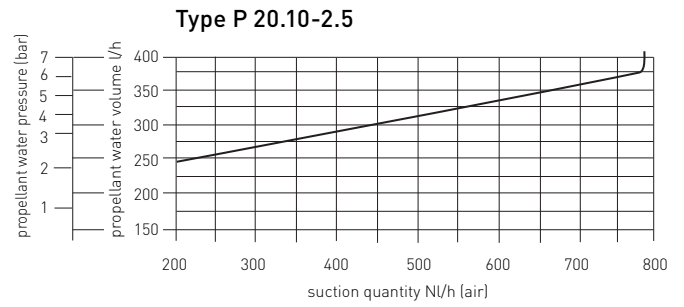
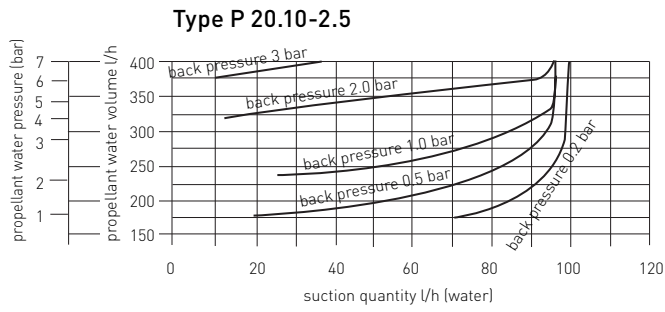
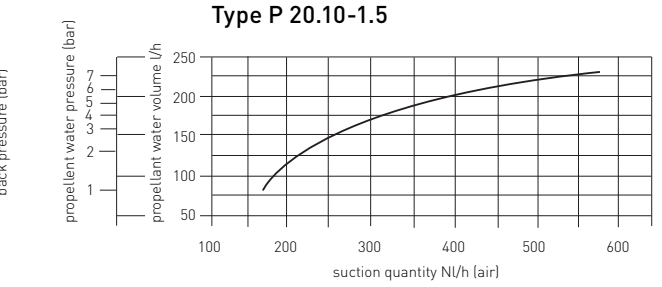

Output diagram for water jet suction pump P 20.15

Suction medium: water

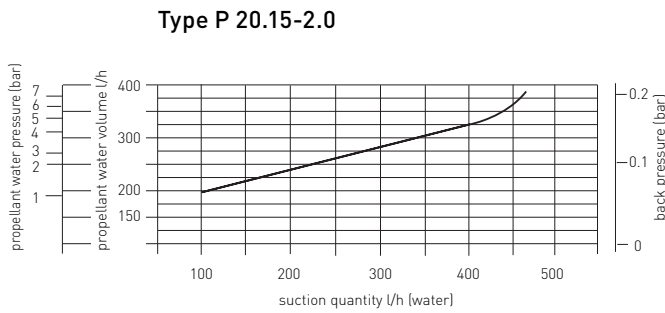

Suction medium: air

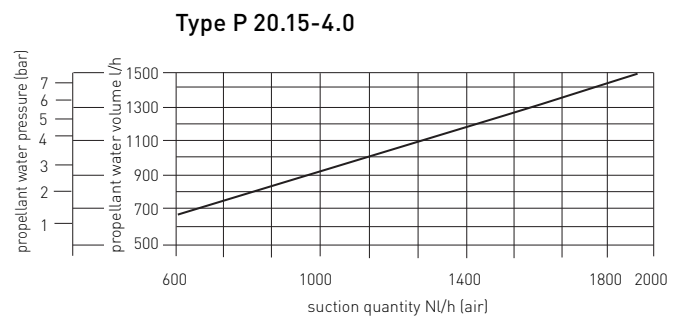
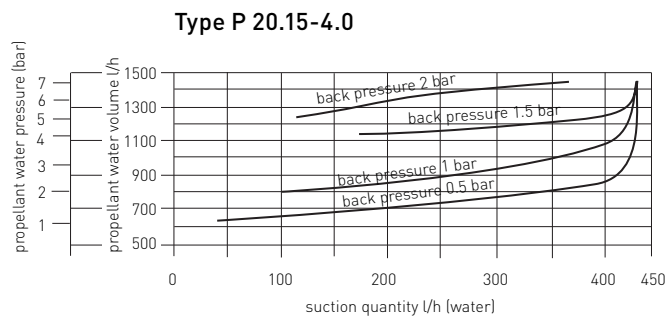
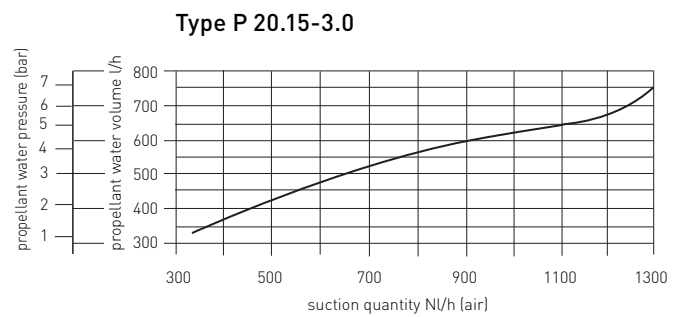
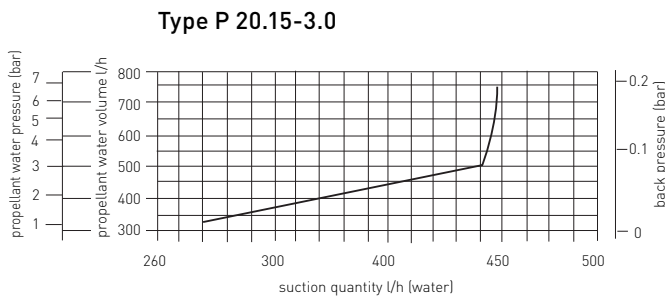
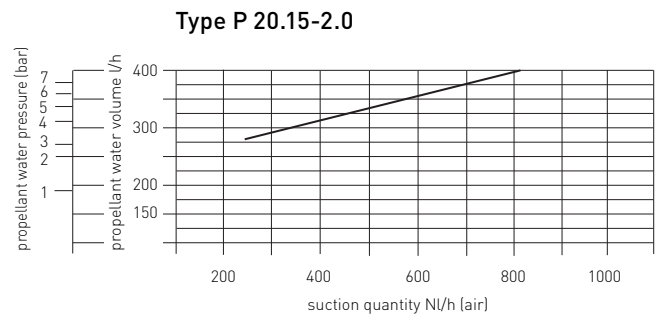

Output diagram for water jet suction pump P 20.20

Suction medium: water

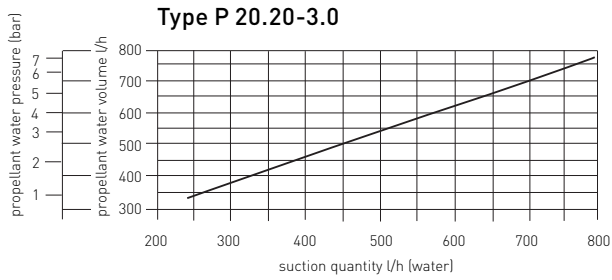

Suction medium: air

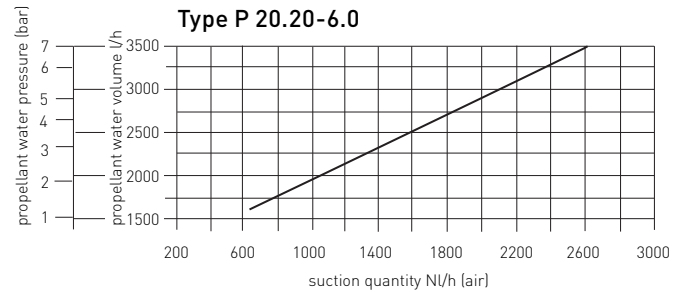
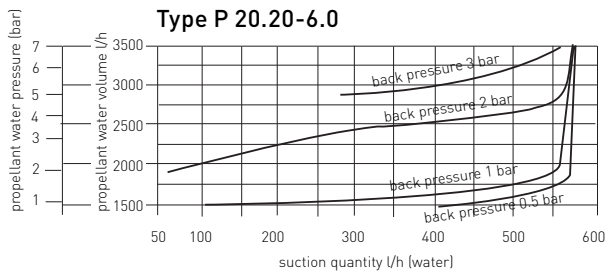
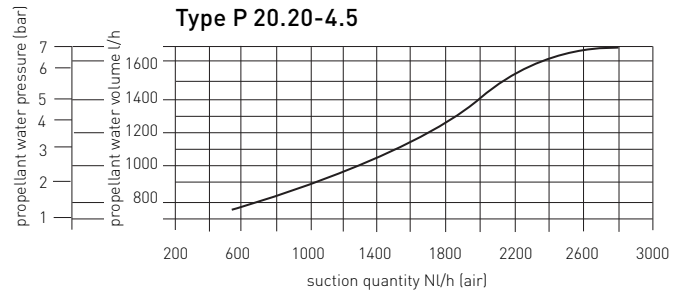
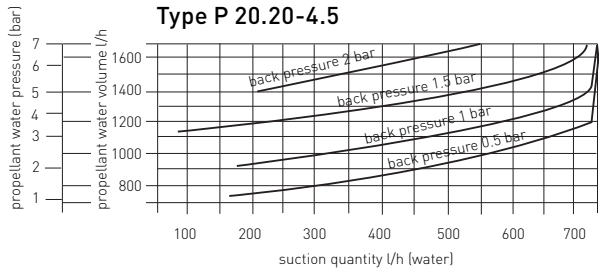
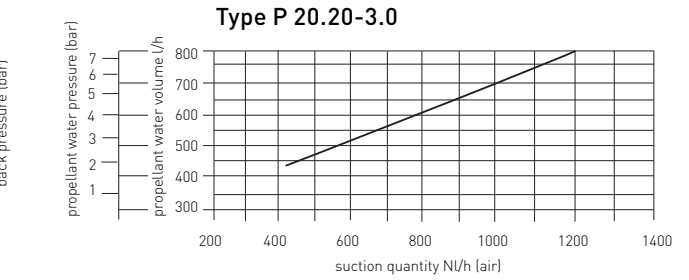

Output diagram for water jet suction pump P 20.25

Suction medium: water

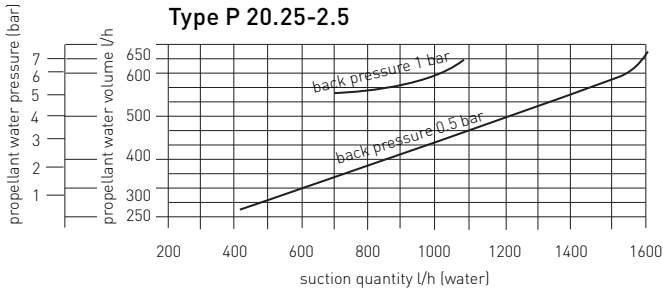

Suction medium: air

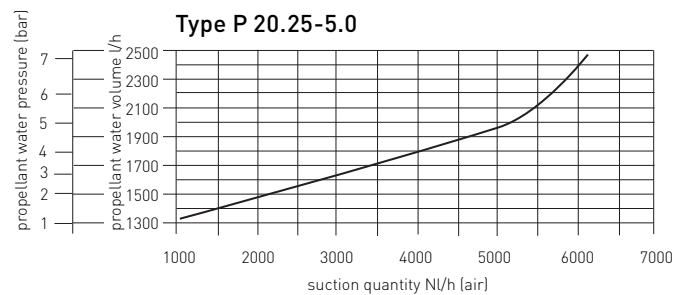
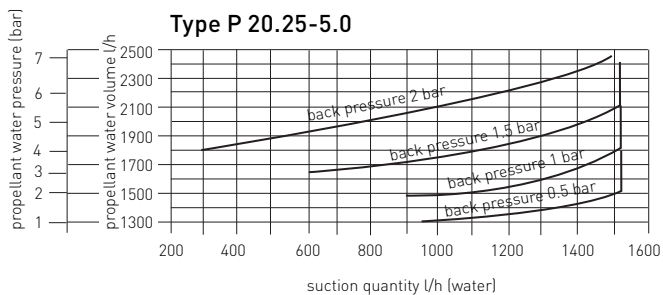
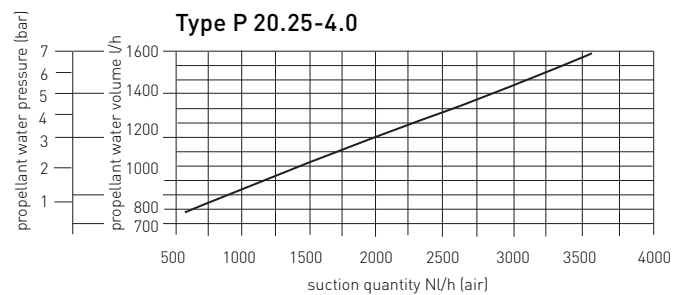
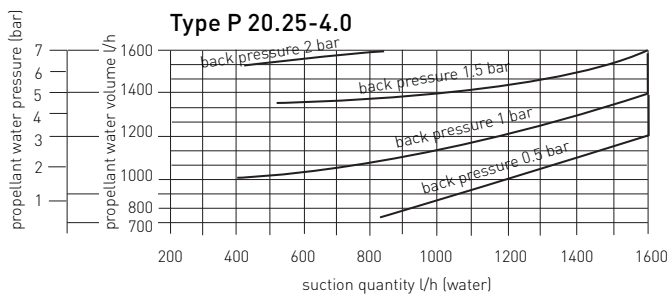
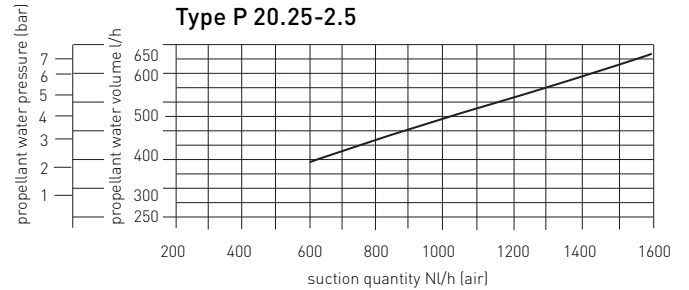

Output diagram for water jet suction pump P 20.32

Suction medium: water

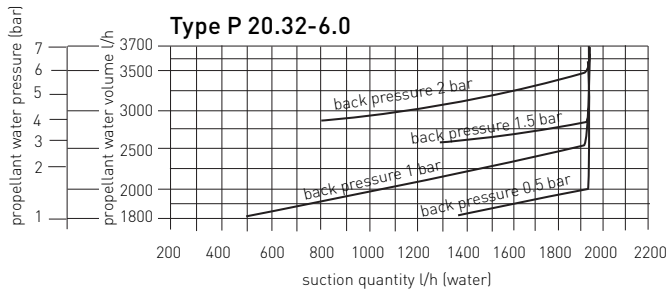
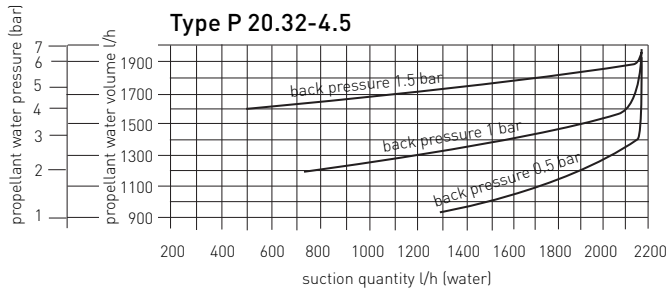
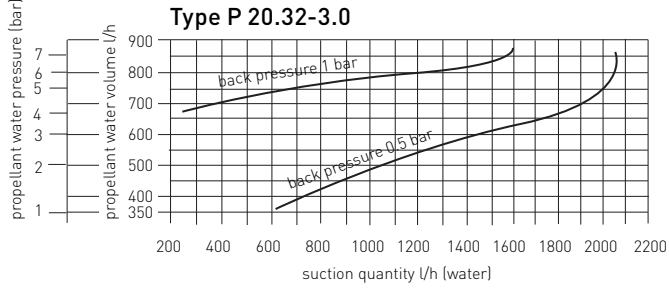

Suction medium: air

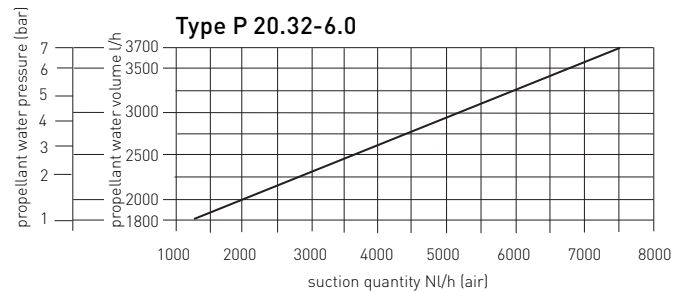
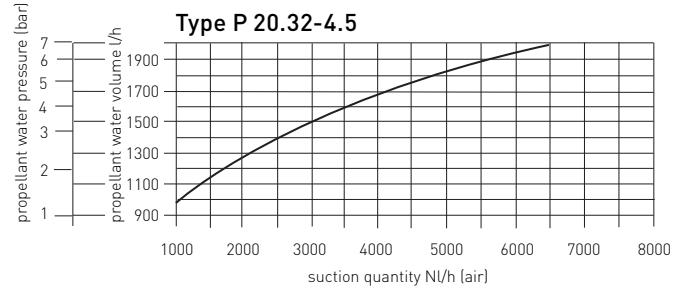
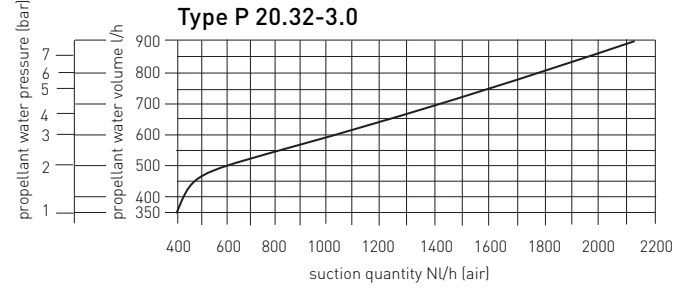

Output diagram for water jet suction pump P 20.40

Suction medium: water

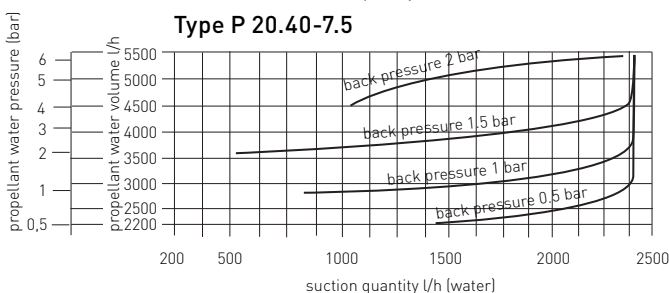
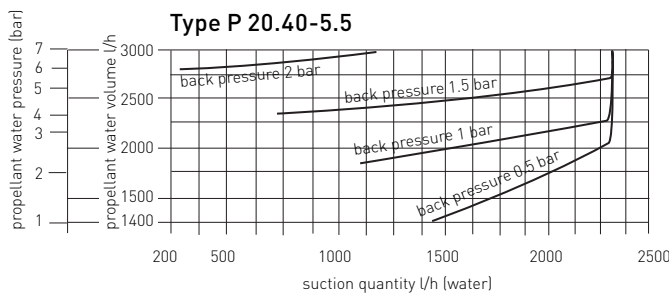
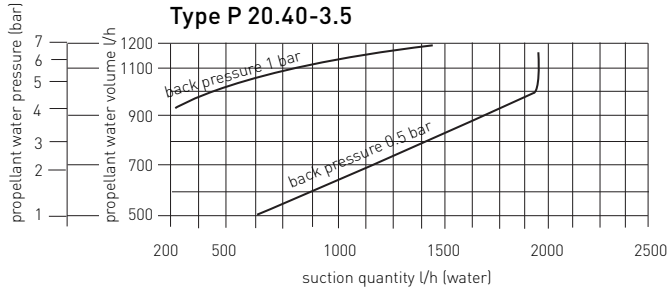

Suction medium: air

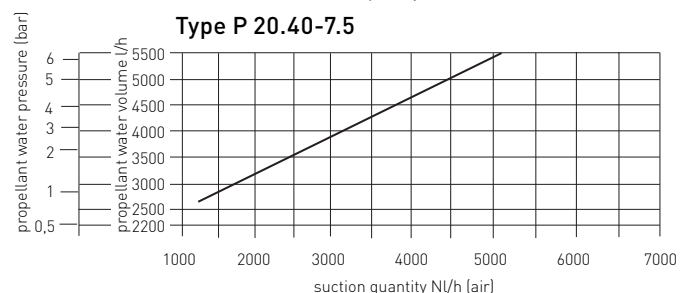
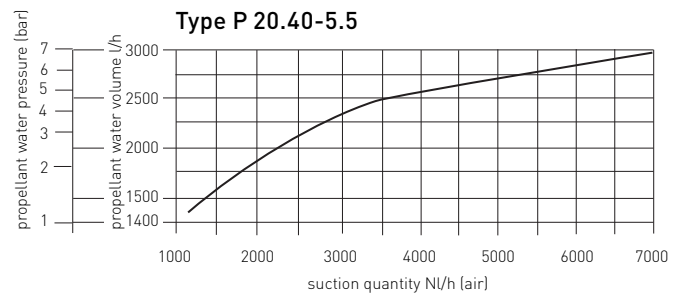
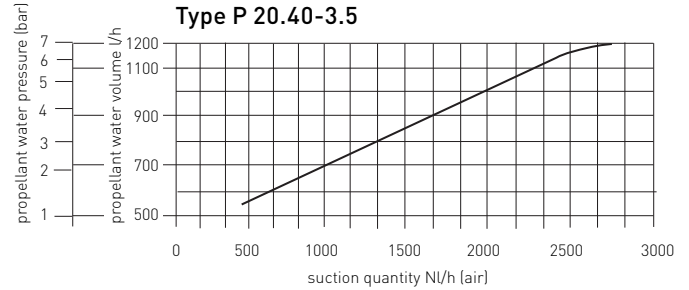

Output diagram for water jet suction pump P 20.50

Suction medium: water

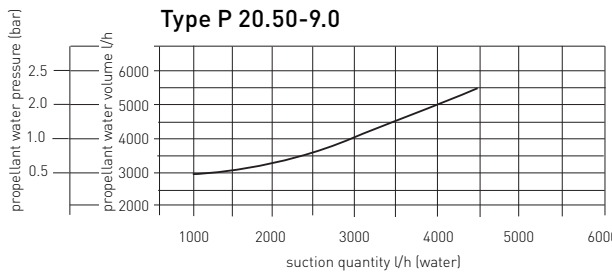
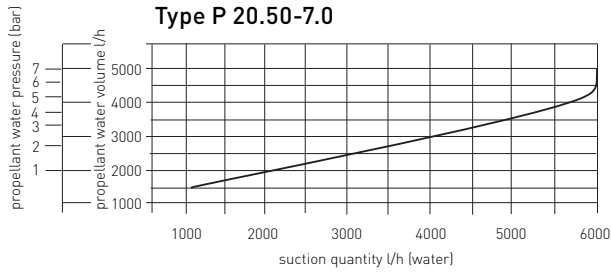
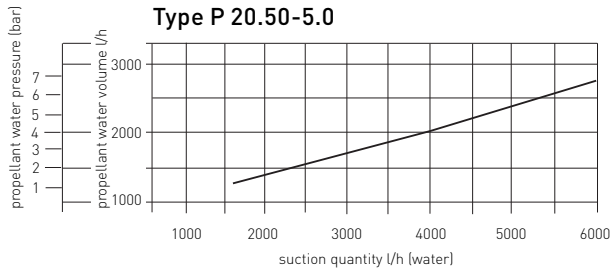

Suction medium: air

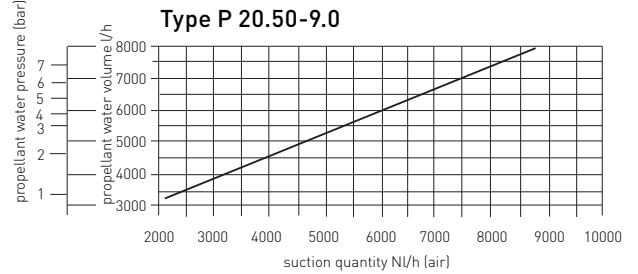
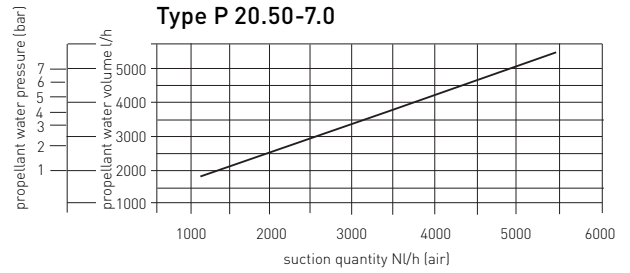
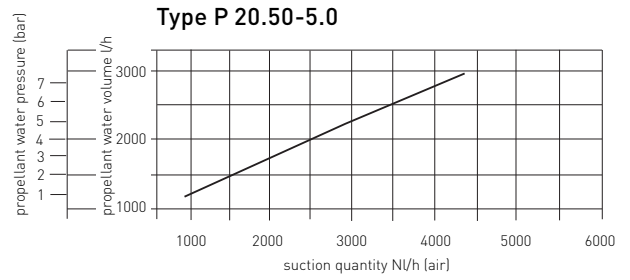

Output diagram for water jet suction pump P 20.65

Suction medium: water

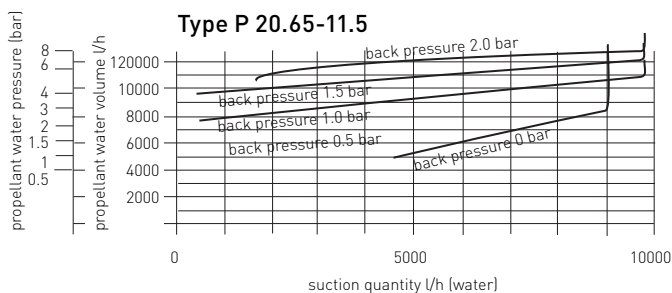
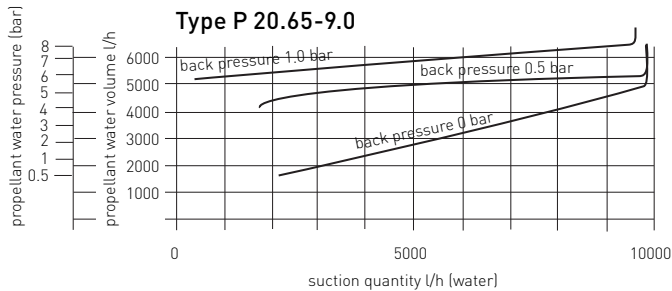
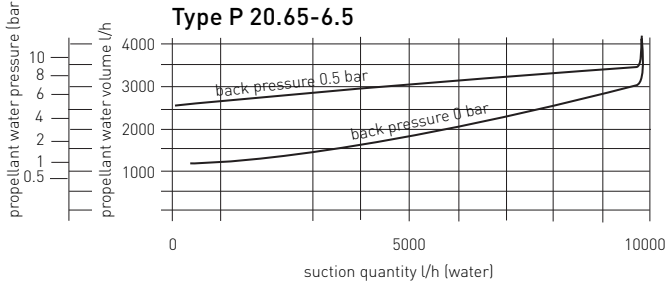

Suction medium: air

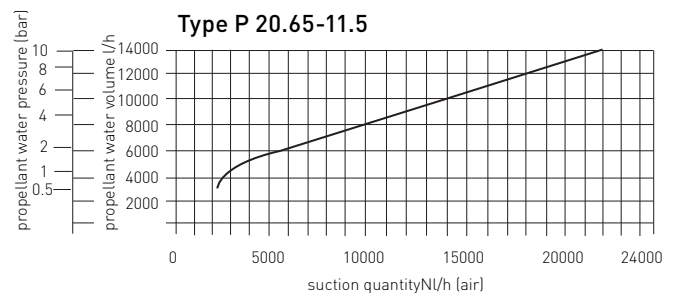
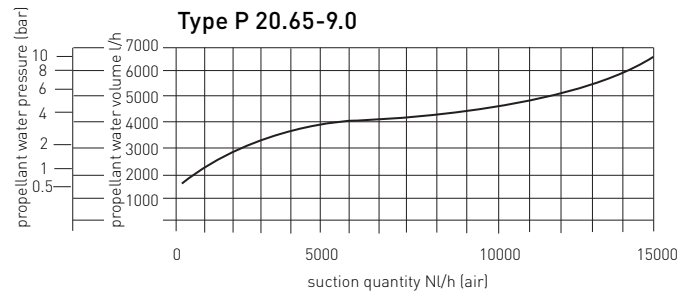
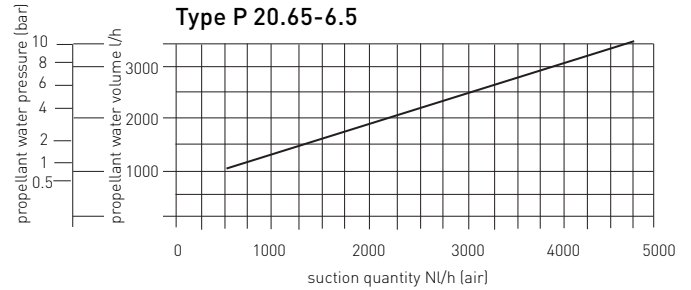

Output diagram for water jet suction pump P 20.80

Suction medium: water

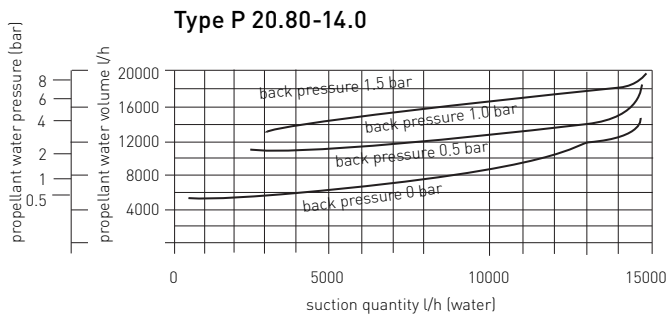
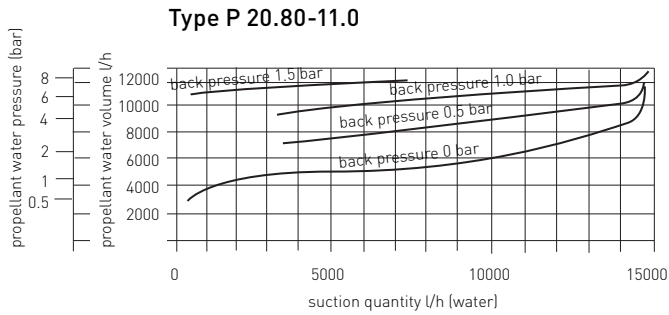
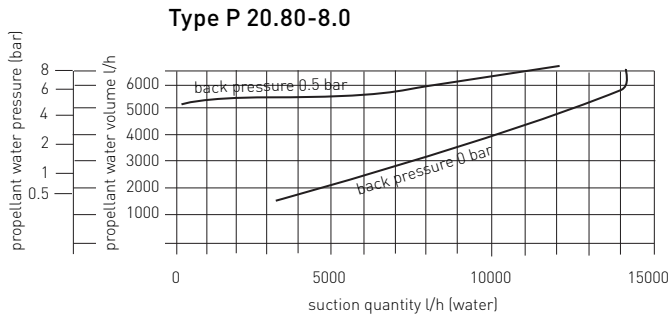

Suction medium: air

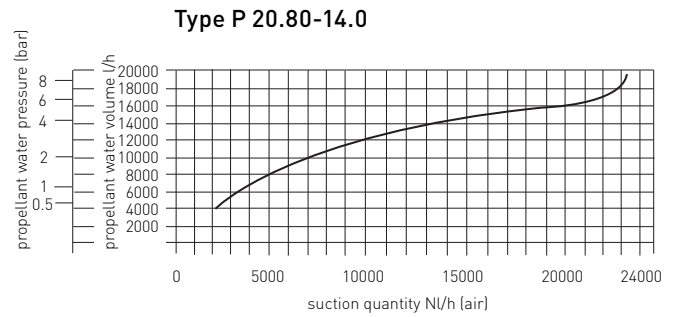
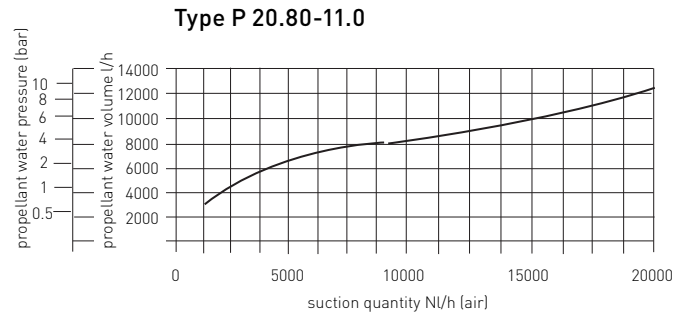
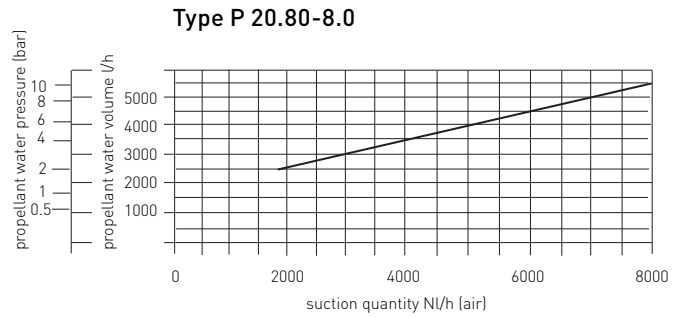

Installation advice

- We recommend installing the water jet pump between two detachable pipe sections. With a view to subsequent dismantling, it is useful to provide shut-off devices.
- Settling sections of at least 5 x DN are to be provided upstream and downstream of the pump.
- It is recommended that a flowmeter is installed in the suction line to provide information on the suction power of the pump.
- It is useful to install manometers upstream and downstream of the jet pump for reading the inlet pressure and the back pressure.

- The suction time can be significantly reduced by installing a check valve in the suction line.
- Inlet and outlet lines must have at least the nominal bore of the pump.
- The propellant and suction flow can be accurately controlled by installing throttle fittings.

Advice on faults

Faults can occur if, for example, the operating water pressure fluctuates or is too low, if the back pressure is too high or if the nozzles are dirty or blocked.

Maximum possible vacuum for water jet pumps P20 DN 10–DN 50

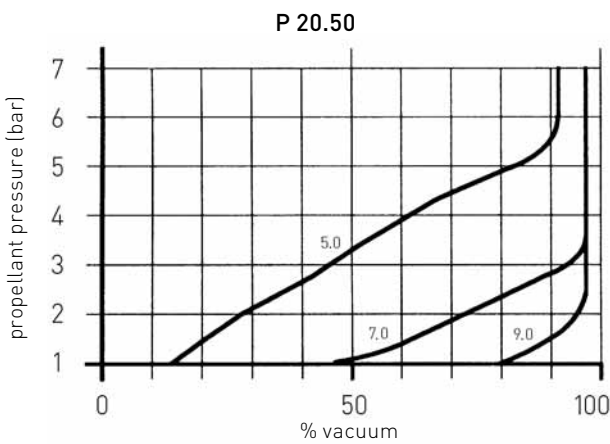
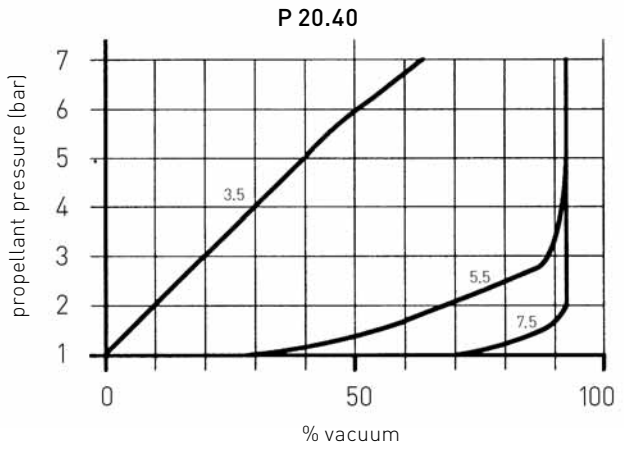
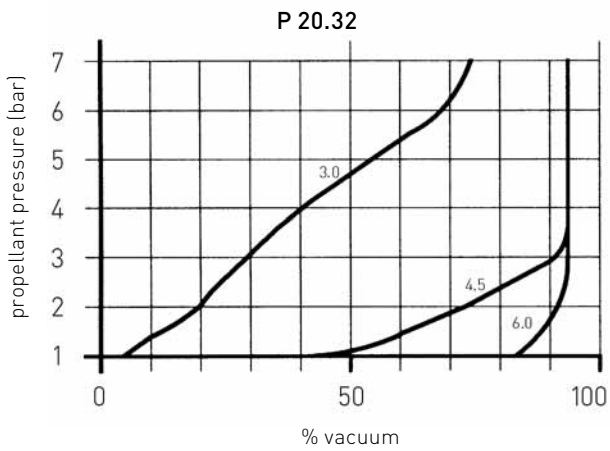
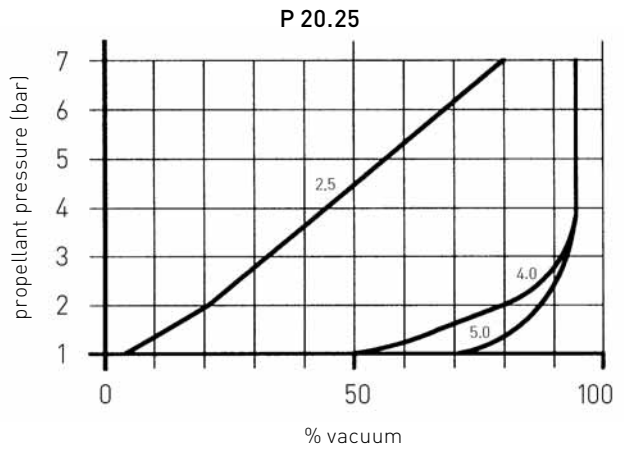
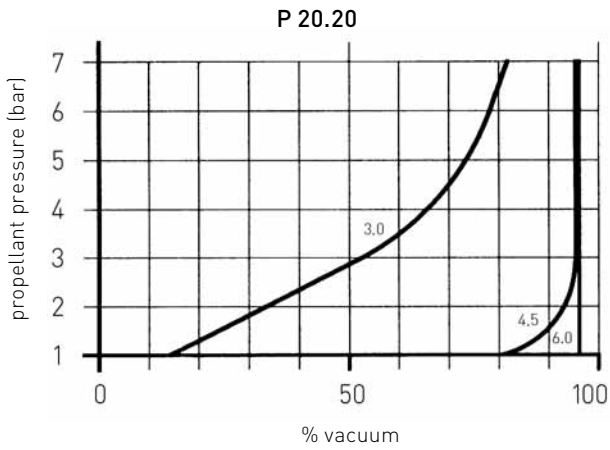
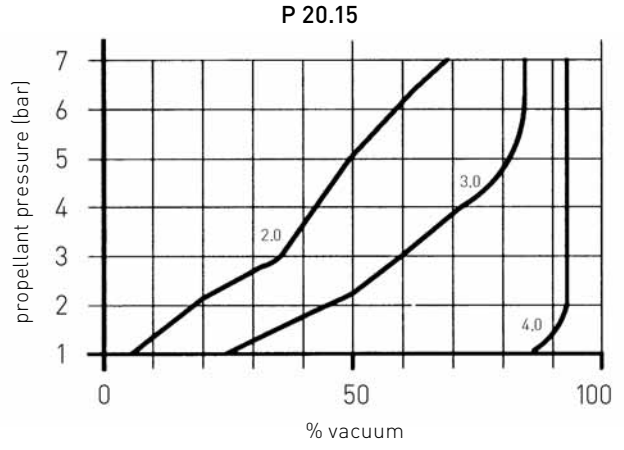
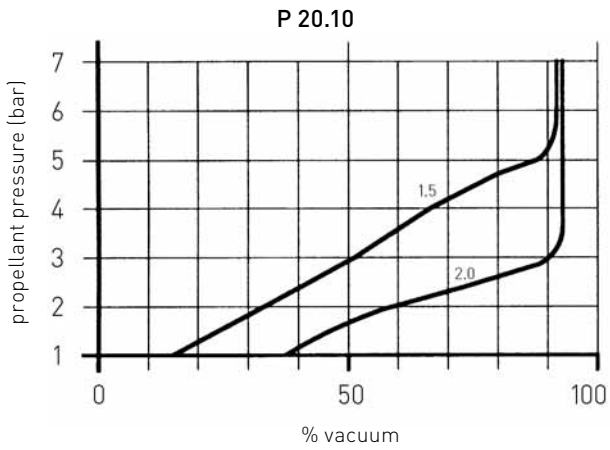

Note
The figures on the curves (e.g. 3.0) are the diameters of the nozzles in each case

Maximum possible vacuum for water jet pumps P20 DN 65–DN 80

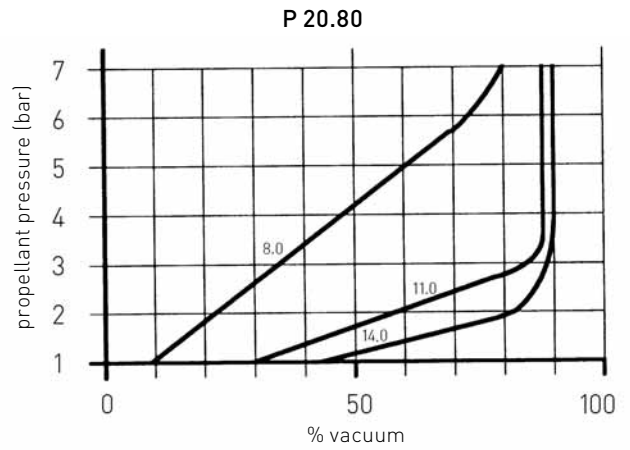
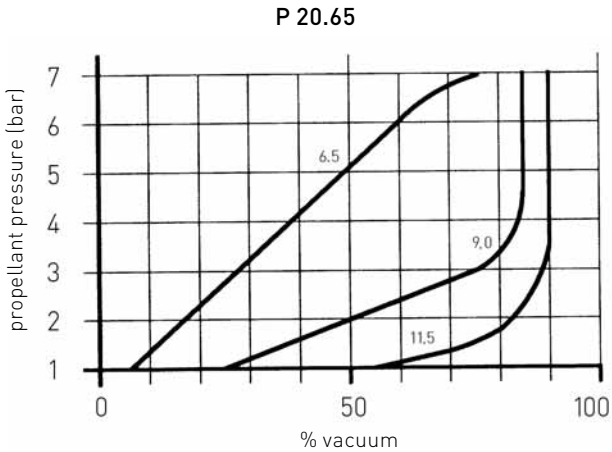

Design of a water jet suction pump

Required specifications:

Example:

Data acc. to diagram:

Prop. water pressure: _____ bar	3 _____ bar	3 _____ bar
Prop. water volume: _____ ltr./h	1200 _____ ltr./h	1180 _____ ltr./h
Suction volume: _____ ltr./h	550 _____ ltr./h	1150 _____ ltr./h
Suction medium: _____	Water _____	H ₂ O _____
Back pressure: _____ bar	1 _____ bar	1 _____ bar

The suction volume must be throttled to the desired amount.

Selected type:



Type P 20.25-4.0

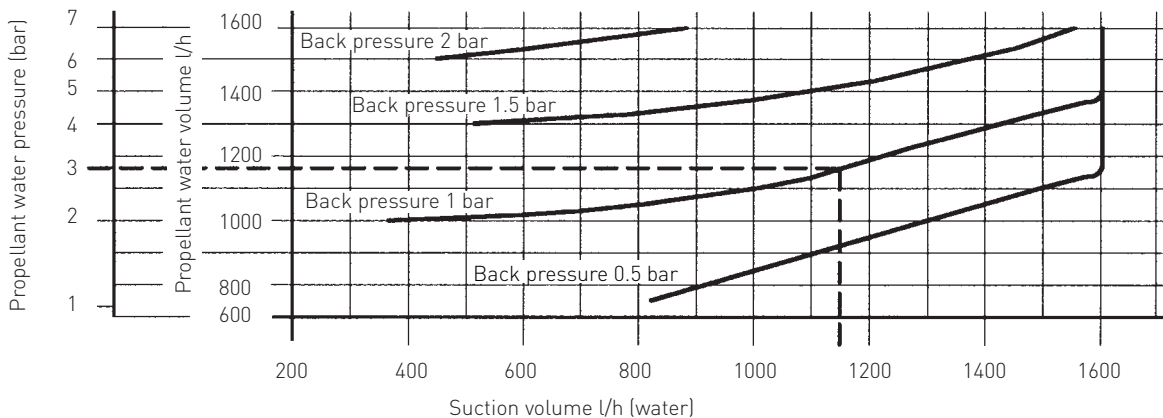

Important!

Do not use a diaphragm valve to adjust the suction volume, because the negative pressure could cause the diaphragm to stick to the seat. In this case, we recommend using a throttle sleeve V251 (see page 50).

The characteristics apply to suction media with the density of water. For media with other densities, please consult us.

Filler Valve V95/Filler and Breather Valve V91



General

Function

The V95/V91 filler and breather valves are primarily used where containers and pipes have to be aerated and/or vented. The float in the V95/V91 opens the valve if the level of the liquid falls. If the level of the liquid rises, the float is raised and pressed against a seal. The valve is then closed. For correct functioning, it is important that the V95/V91 filler and breather valves are installed vertically with the arrow pointing «up».

Special features

- All parts in contact with the medium are made of highly resistant plastics
- No auxiliary energy is required to operate the fitting
- The V95/V91 valve is largely maintenance-free

Technical data

Available materials

V95/V91: PVC-U, PP, PVDF
Seal: FPM

Ball material: PP (cone)
PVDF (float)

Spring: Equivalent to housing material

Allowable working temperature

PVC-U 0 to + 60 °C
PP -10 to + 80 °C
PVDF -20 to + 100 °C

Allowable working pressure

max. 10 bar to 20 °C

Dimensions and weight V95

da	DN	ØD	L	t	Weight PVC-U (kg)	Weight PP (kg)	Weight PVDF (kg)
16	10	35	114	14	0.10	0.07	0.17
20	15	40	124	16	0.14	0.10	0.24
25	20	45	144	19	0.19	0.14	0.33
32	25	55	154	22	0.28	0.20	0.50
40	32	70	174	26	0.55	0.39	0.98
50	40	80	194	31	0.71	0.50	1.27
63	50	95	224	38	1.28	0.91	2.30
75	65	115	284	44	1.90	1.36	3.42
90	80	150	300	51	3.23	2.30	5.81

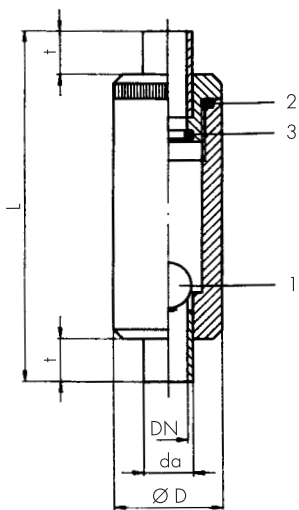

Filler and breather valve V91

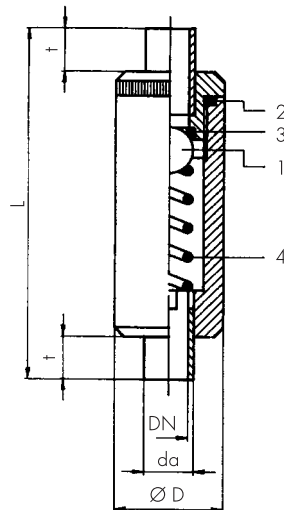

Filler valve V95

The opening pressure of the V95 filler valve cannot be defined accurately, since the plastic spring does not have a constant spring characteristic. As a guideline, an opening pressure of 0.04–0.13 bar depending on the DN can be expected. However, these values are not binding and can fluctuate greatly depending on the operating conditions and operating duration.

Parts

No.	Description	Units
1.	Ball	1
2.	O-ring	1
3.	O-ring	1
4.	Spring	1

Air volume diagram

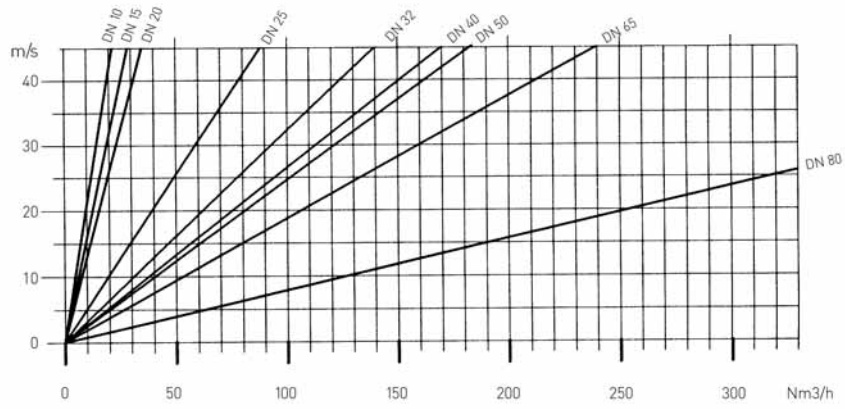

Design recommendation up to 20 m/s

Order number V91/V95

DN	da	PVC-U V91 FPM	PP V91 FPM	PVDF V91 FPM	PVC-U V95 FPM	PP V95 FPM	PVDF V95 FPM
10	16	199 041 238	199 041 247	199 041 256	199 041 265	199 041 274	199 041 283
15	20	199 041 239	199 041 248	199 041 257	199 041 266	199 041 275	199 041 284
20	25	199 041 240	199 041 249	199 041 258	199 041 267	199 041 276	199 041 285
25	32	199 041 241	199 041 250	199 041 259	199 041 268	199 041 277	199 041 286
32	40	199 041 242	199 041 251	199 041 260	199 041 269	199 041 278	199 041 287
40	50	199 041 243	199 041 252	199 041 261	199 041 270	199 041 279	199 041 288
50	63	199 041 244	199 041 253	199 041 262	199 041 271	199 041 280	199 041 289
65	75	199 041 245	199 041 254	199 041 263	199 041 272	199 041 281	199 041 290
80	90	199 041 246	199 041 255	199 041 264	199 041 273	199 041 282	199 041 291

Float Valve V140 DN 10–DN 80



General

Application

The V140 float valves are used to automatically control the supply to tanks and vessels. In this way, a constant level can be maintained.

Function

The V140 float valve is fastened to the vessel wall at the desired level and connected to the supply line. When the fluid level rises, the float is lifted and closes the valve via the lever arm. When the fluid level sinks, the supply line is opened and the medium can enter until the respective level is reached again.

Special features

- Optimal level control without auxiliary energy
- Robust and low-maintenance design
- Operational safety thanks to integrated seat seal
- Lever ratio
 - standard 1:10
 - on request 1:7 for tight installation space

Technical data V140

Material:	PVC, PP	Mounting position:	vertical
Sealing element:	EPDM, FPM (Viton)	Connection:	Cement or fusion spigots per DIN.
Bearing axis:	1.4571		With unions or flange on request
Allowable working pressure:	max. 6 bar at 20 °C		

Dimensions and weight V140

da	DN	Ø D	H	a	b	C		e	A	Ø SD	SH
						Lever 1:10	Lever 1:7				
16	10	45	120	80	36	380	305	14	270	125	130
20	15	45	120	80	36	380	305	16	270	125	130
25	20	65	160	110	50	530	430	19	340	160	170
32	25	65	165	110	50	530	430	22	345	160	170
40	32	90	210	130	65	720	575	26	440	225	210
50	40	90	215	130	65	720	575	31	445	225	210
63	50	130	255	160	86	975	775	38	595	315	290
75	65	130	260	160	86	975	775	44	600	315	290
90	80	150	290	180	101	1140	905	51	640	355	340

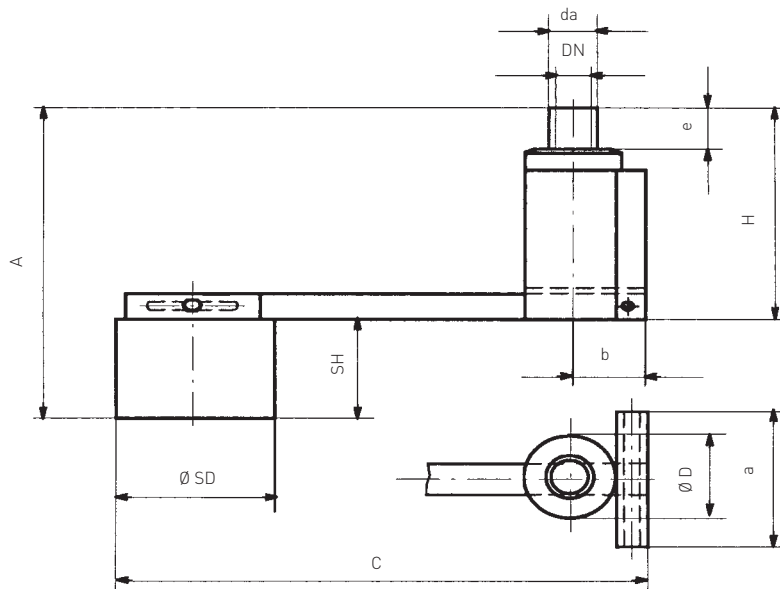

Order number V140

DN	da	PVC with cement spigots		PP with fusion spigots	
		EPDM	FPM	EPDM	FPM
10	16	199 041 147	199 041 156	199 041 165	199 041 174
15	20	199 041 148	199 041 157	199 041 166	199 041 175
20	25	199 041 149	199 041 158	199 041 167	199 041 176
25	32	199 041 150	199 041 159	199 041 168	199 041 177
32	40	199 041 151	199 041 160	199 041 169	199 041 178
40	50	199 041 152	199 041 161	199 041 170	199 041 179
50	63	199 041 153	199 041 162	199 041 171	199 041 180
65	75	199 041 154	199 041 163	199 041 172	199 041 181
80	90	199 041 155	199 041 164	199 041 173	199 041 182

Throttle Sleeve V251 DN 10–DN 50



General

Application

Throttle sleeves are used wherever fluids or gases need to be throttled in pipelines. The compact design, simple and robust construction and good control characteristics ensure high operational safety.

Function

A spindle with cone narrows down the cross-section of the opening in the housing, thereby restricting the volume flow to the desired value. The setting must be done with a tool (screwdriver or flat material) which has the advantage that the set value cannot be changed unintentionally.

Special features

- Good chemical resistance due to highly resistant plastics (PVC, PP, PVDF)
- Requires practically no maintenance and can be installed in any position
- High operational safety thanks to compact and robust construction
- Good control characteristics from 0 to max. volume

Technical data V251

Available materials

Housing: PVC-U, PP, PVDF
 Seal: EPDM/FPM

Allowed working temperature

PVC-U 0 to + 60 °C
 PP -10 to + 80 °C
 PVDF -20 to + 100 °C

Allowed working pressure

PN 10 at 20 °C

Dimensions V251

da	DN	L	H	h	Ø D
16	10	47	57	45	29
20	15	55	66	51	35
25	20	66	80	62.5	40
32	25	80	96	74.5	47
40	32	100	111	86	56
50	40	120	133	101	70
63	50	146	158	118	88

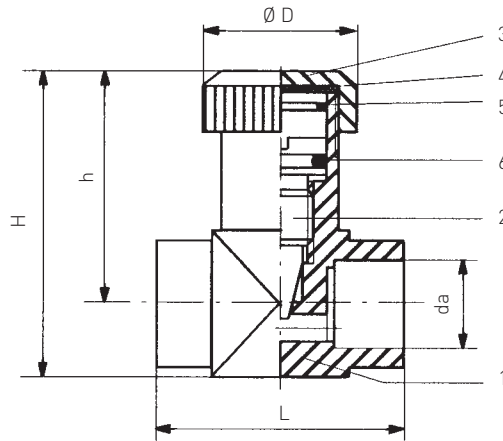

Parts

No.	Description	Units
1.	Housing	1
2.	Spindle	1
3.	Cap	1
4.	Seal	1
5.	Stop ring	1
6.	O-ring	1

Order number V251

DN	da	PVC		PP		PVDF
		EPDM	FPM	EPDM	FPM	FPM
10	16	199 041 203	199 041 210	199 041 217	199 041 224	199 041 231
15	20	199 041 204	199 041 211	199 041 218	199 041 225	199 041 232
20	25	199 041 205	199 041 212	199 041 219	199 041 226	199 041 233
25	32	199 041 206	199 041 213	199 041 220	199 041 227	199 041 234
32	40	199 041 207	199 041 214	199 041 221	199 041 228	199 041 235
40	50	199 041 208	199 041 215	199 041 222	199 041 229	199 041 236
50	63	199 041 209	199 041 216	199 041 223	199 041 230	199 041 237

Subject to technical changes for reasons of improvement!

Performance diagram for throttle sleeves V251

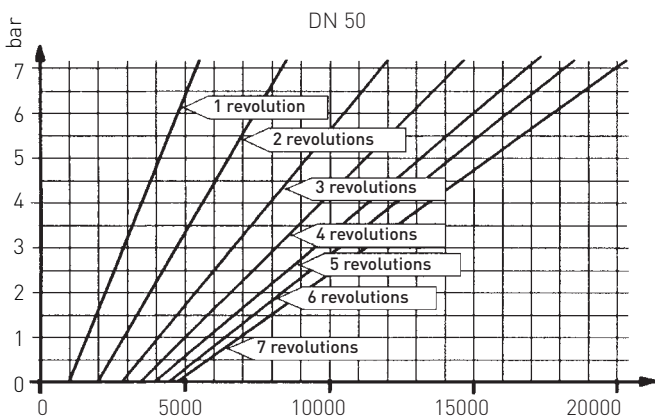
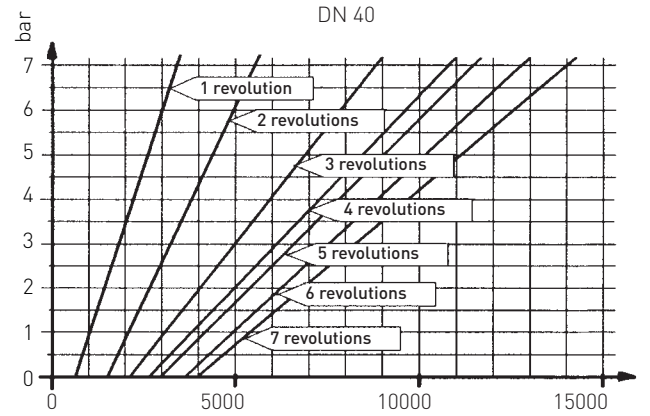
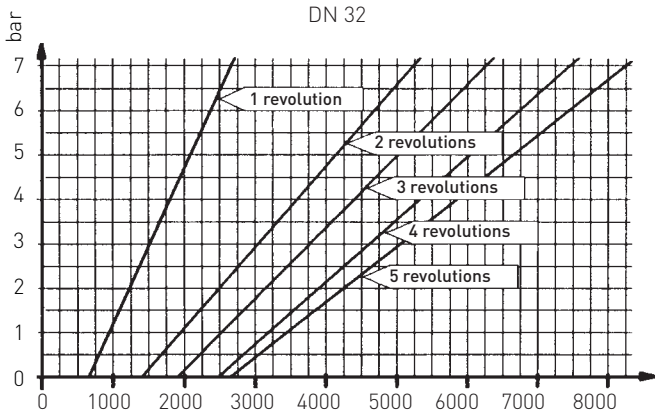
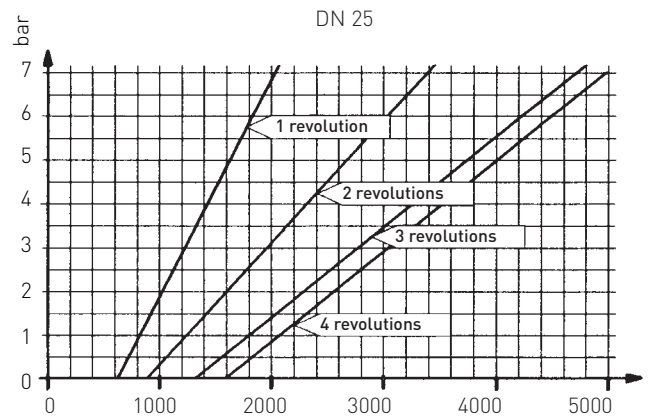
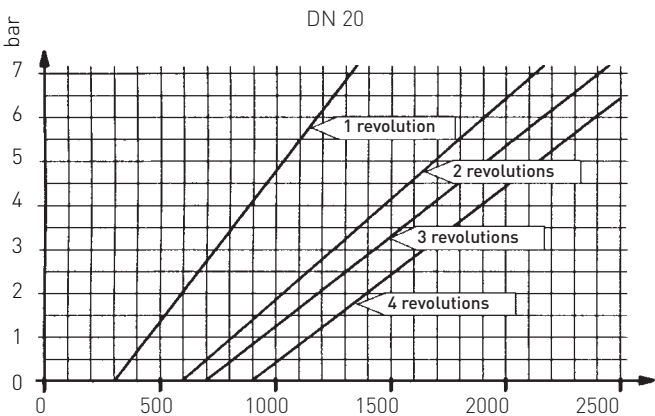
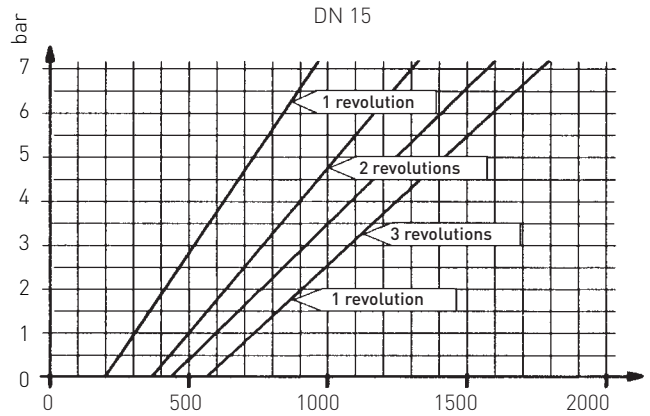
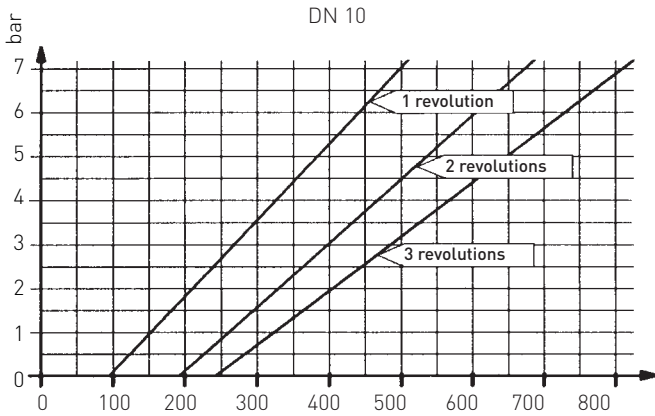

l/hr = flow volume H₂O

To dimension the nominal diameter, we recommend using the given values with a half-opened throttle sleeve.

Example:

Pressure upstream: 3 bar
Desired flow: 2000 l/hr

According to the diagram for DN 25, the flow is 2000 l/hr when the adjusting screw is opened 2 revolutions. The nominal diameter of DN 25 is a good choice.

Flow volumes in pipelines

l/hr flow volume at a velocity of v=

Nom. diam. mm	inch	Area of nom. diam. mm ²	2.0 m/s									
			3.0 m/s	2.5 m/s	l/hr	l/min	1.8 m/s	1.6 m/s	1.4 m/s	1.2 m/s	1.0 m/s	0.5 m/s
10	1/8"	78.5	848	706	565	9.4	509	452	396	339	283	141
15	1/2"	176.6	1901	1584	1267	21.1	1140	1014	887	760	634	317
20	3/4"	314.0	3391	2826	2261	37.7	2035	1809	1583	1357	1130	565
25	1"	490.6	5292	4410	3528	58.8	3175	2822	2470	2117	1764	882
32	1 1/4"	803.8	8672	7227	5782	96.4	5203	4626	4047	3469	2891	1445
40	1 1/2"	1256.0	13565	11304	9043	150.7	8139	7235	6330	5426	4522	2261
50	2"	1962.5	21190	17658	14126	235.4	12714	11301	9888	8476	7063	3532
65	2 1/2"	3316.6	35813	29844	23875	397.9	21488	19100	16713	14325	11938	5969
80	3"	5024.0	54259	45216	36173	602.9	32556	28938	25321	21704	18086	9043
100	4"	7850.0	84780	70650	56520	942.0	50868	45216	39564	33912	28260	14130
125	5"	12265.6	132462	110385	88308	1471.8	79477	70646	61816	52985	44154	22077
150	6"	17662.5	190750	158958	127166	2119.4	114450	107733	89017	76300	63583	31792

$Q = \text{flow volume (m}^3/\text{h)}$ $Q = F \times 3600 \times v = \text{m}^3/\text{h}$
 $F = \text{area (of nominal diameter m}^2)$ $F = \frac{Q}{v \times 3600} = \text{m}^2$
 $v = \text{velocity (m/s)}$ $v = \frac{Q}{F \times 3600} = \text{m/s}$

Note
 The nominal diameter of our valves can be determined on the basis of this table.
 We recommend not exceeding a velocity of 2.0 m/s.

Applications

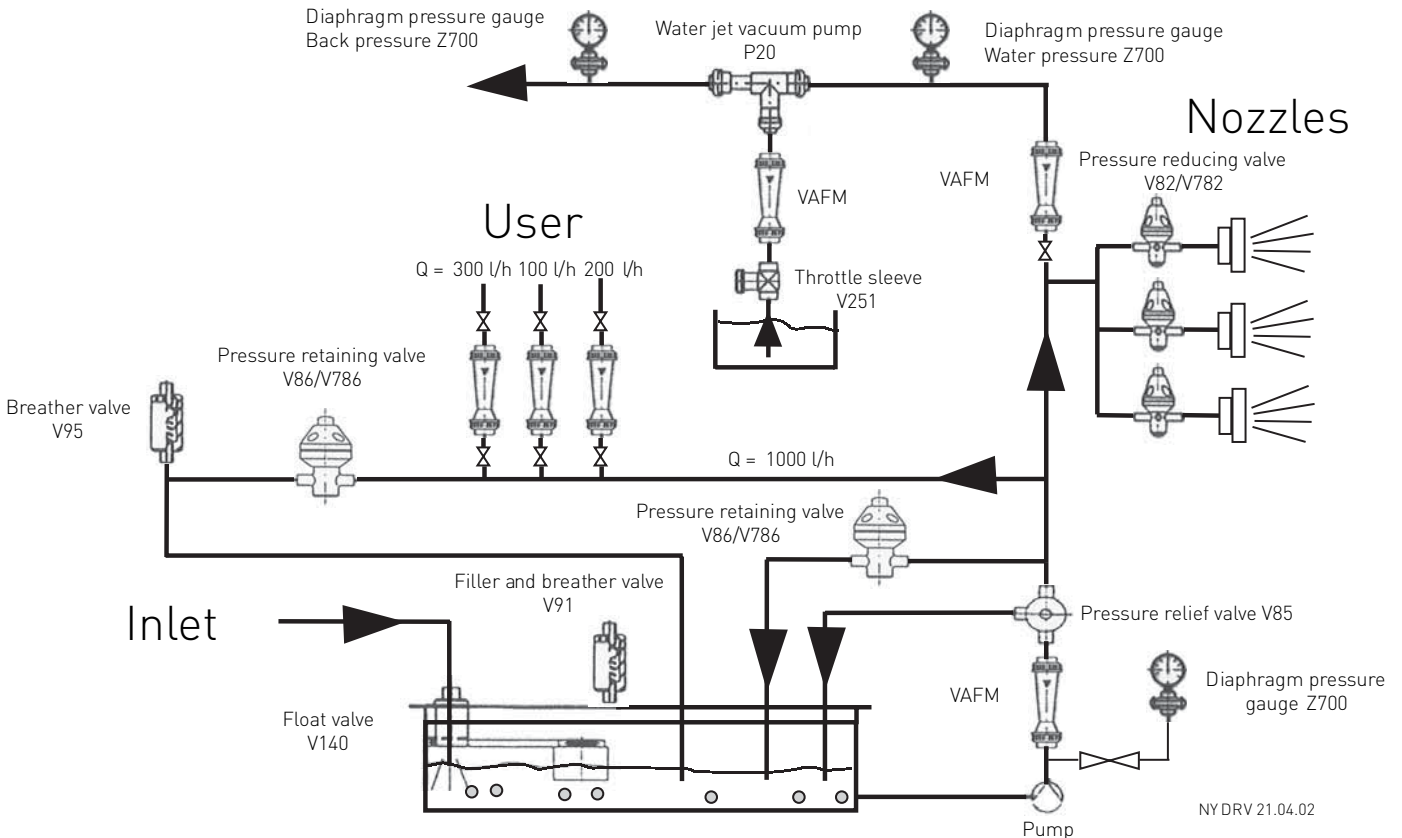

NY DRV 21.04.02

GF Piping Systems → worldwide



Our sales companies and representatives ensure local customer support in over 100 countries.

Please find more information:
www.piping.georgfischer.com

The technical data is not binding and not an expressly warranted characteristic of the goods. It is subject to change. Our General Conditions of Sale apply.

Australia

George Fischer Pty Ltd
Kingsgrove NSW 2008
Phone +61(0)2/95 54 39 77
australia.ps@georgfischer.com
www.georgfischer.com.au

Austria

Georg Fischer
Rohrleitungssysteme GmbH
3130 Herzogenburg
Phone +43(0)2782/856 43-0
austria.ps@georgfischer.com
www.georgfischer.at

Belgium/Luxembourg

Georg Fischer NV/SA
1070 Bruxelles/Brüssel
Phone +32(0)2/556 40 20
be.ps@georgfischer.com
www.georgfischer.be

Brazil

George Fischer Ltda
04795-100 São Paulo
Phone +55(0)11/5687 1311
br.ps@georgfischer.com

China

Georg Fischer Piping Systems Ltd Shanghai
Pudong, Shanghai 201319
Phone +86(0)21/58 13 33 33
china.ps@georgfischer.com
www.cn.piping.georgfischer.com

Denmark/Iceland

Georg Fischer A/S
2630 Taastrup
Phone +45 (0)70 22 19 75
info.dk.ps@georgfischer.com
www.georgfischer.dk

France

George Fischer S.A.S.
93208 Saint-Denis Cedex 1
Phone +33(0)1/492 21 34 1
fr.ps@georgfischer.com
www.georgfischer.fr

Germany

Georg Fischer GmbH
73095 Albershausen
Phone +49(0)7161/302-0
info.de.ps@georgfischer.com
www.vgd.georgfischer.de

Georg Fischer DEKA GmbH
35232 Dautphetal-Mornshausen
Phone +49(0)6468/915-0
deka.ps@georgfischer.com
www.dekapipe.de

India

Georg Fischer Piping Systems Ltd
400 093 Mumbai
Phone +91(0)22/2820 2362
in.ps@georgfischer.com

Italy

Georg Fischer S.p.A.
20063 Cernusco S/N (MI)
Phone +3902/921 861
it.ps@georgfischer.com
www.georgfischer.it

Japan

Georg Fischer Ltd
556-0011 Osaka,
Phone +81(0)6/6635 2691
jp.ps@georgfischer.com
www.georgfischer.jp

Malaysia

Georg Fischer (M) Sdn. Bhd.
47500 Subang Jaya
Phone +60 (0)3-8024 7879
conne.kong@georgfischer.com.my

Netherlands

Georg Fischer N.V.
8161 PA Epe
Phone +31(0)578/678 222
nl.ps@georgfischer.com
www.georgfischer.nl

Norway

Georg Fischer AS
1351 Rud
Phone +47(0)67 18 29 00
no.ps@georgfischer.com
www.georgfischer.no

Poland

Georg Fischer Sp. z o.o.
02-226 Warszawa
Phone +48(0)22/313 10 50
poland.ps@georgfischer.com
www.georgfischer.pl

Romania

Georg Fischer
Rohrleitungssysteme AG
70000 Bucharest - Sector 1
Phone +40(0)1/222 91 36
ro.ps@georgfischer.com

Singapore

George Fischer Pte Ltd
417 845 Singapore
Phone +65(0)67 47 06 11
sgp.ps@georgfischer.com
www.georgfischer.com.sg

Spain/Portugal

Georg Fischer S.A.
28046 Madrid
Phone +34(0)91/781 98 90
es.ps@georgfischer.com
www.georgfischer.es

Sweden/Finland

Georg Fischer AB
12523 Älvsjö-Stockholm
Phone +46(0)8/506 775 00
info.se.ps@georgfischer.com
www.georgfischer.se

Switzerland

Georg Fischer Rohrleitungssysteme (Schweiz) AG
8201 Schaffhausen
Phone +41(0)52 631 30 26
ch.ps@georgfischer.com
www.piping.georgfischer.ch

United Kingdom/Ireland

Georg Fischer Sales Limited
Coventry, CV2 2ST
Phone +44(0)2476 535 535
uk.ps@georgfischer.com
www.georgfischer.co.uk

USA/Canada/Latin America/Caribbean

George Fischer Inc.
Tustin, CA 92780-7258
Phone +1(714) 731 88 00, Toll Free 800/854 40 90
us.ps@georgfischer.com
www.us.piping.georgfischer.com

Export

Georg Fischer Rohrleitungssysteme (Schweiz) AG
8201 Schaffhausen
Phone +41(0)52 631 11 11
export.ps@georgfischer.com
www.piping.georgfischer.com